



BOSTON MEDICAL LIBRARY  
in the Francis A. Countway  
Library of Medicine ~ *Boston*

Digitized by the Internet Archive  
in 2011 with funding from  
Open Knowledge Commons and Harvard Medical School







HIGH-FREQUENCY CURRENTS  
IN THE TREATMENT OF  
SOME DISEASES







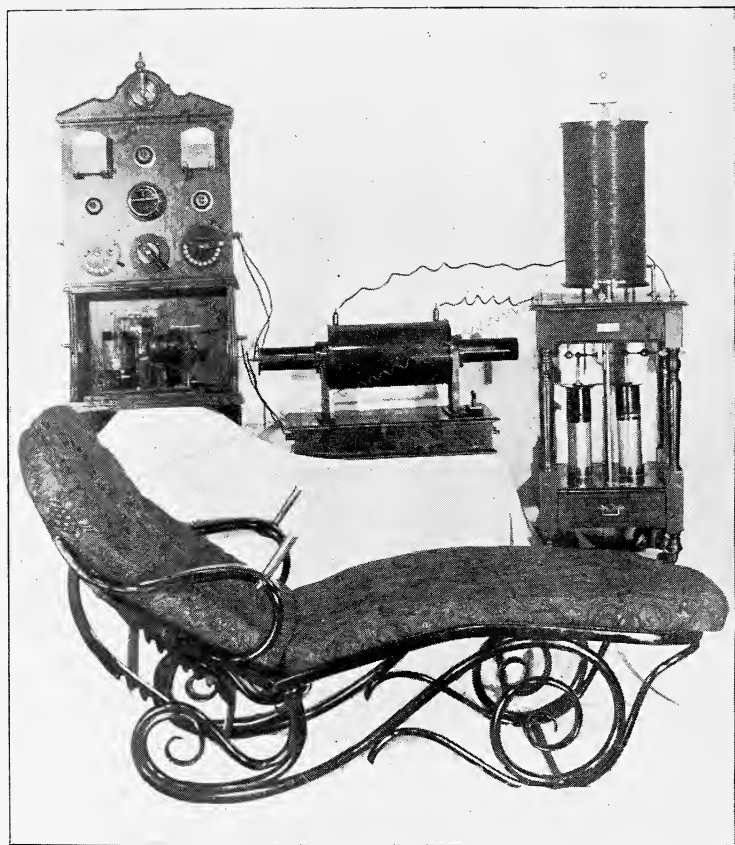

COMPLETE INSTALLATION FOR HIGH-FREQUENCY TREATMENT, COMPRISING SWITCHBOARD WITH DIPPER-BREAK, COIL, OUDIN-DEAN RESONATER, AND COUCH FOR AUTO-CONDENSATION.

*Frontispicce.*

# HIGH-FREQUENCY CURRENTS IN THE TREATMENT OF SOME DISEASES

BY

CHISHOLM WILLIAMS, F.R.C.S. EDIN.

MEMBER ROYAL COLLEGE OF SURGEONS, ENG. ; LICENTIATE ROYAL COLLEGE  
OF PHYSICIANS, LOND. ; LICENTIATE SOCIETY OF APOTHECARIES, LOND. ;  
ELECTRO-THERAPEUTIST WEST LONDON HOSPITAL, W. ; SURGEON  
OUT-PATIENTS CITY ORTHOPÆDIC HOSPITAL, E.C. ; HONORARY  
SECRETARY BRITISH ELECTRO-THERAPEUTIC SOCIETY ; ETC.



NEW YORK

REBMAN COMPANY

10 WEST 23RD STREET, CORNER OF FIFTH AVENUE

1903

4044



## P R E F A C E

AT the request of a number of my medical *confrères*, I have attempted in this little book to offer a short, yet, I hope, fairly concise, account of the treatment of some diseases by means of electrical currents of high frequency and high potential. These currents were brought to my notice as a therapeutic agent in 1898, and at first I was somewhat sceptical of their value, but after an extensive trial I am convinced of their great usefulness IN SOME DISEASES. In the following pages only those conditions have been mentioned with which I have had some experience. Others are purposely omitted until a more extended trial or more statistics have been obtained than at present.

In acknowledging my indebtedness to others,

mention must first be made of Dr. J. Denoyès' book, which gives a most excellent epitome of Continental observers. I am obliged to many medical friends for permission to include cases under their care. Several makers of scientific instruments at home and abroad have kindly lent blocks. It is interesting to note that our 'home manufactures' are unsurpassed for usefulness.

20, BEDFORD SQUARE, W.C.

*May, 1903.*

## CONTENTS

CHAPTER		PAGE
I.	INTRODUCTION—HISTORY - - -	I
II.	SOURCE OF ENERGY - - -	11
III.	THE APPARATUS - - -	45
IV.	PHYSICAL PROPERTIES - - -	91
V.	PHYSIOLOGICAL PROPERTIES - - -	111
VI.	THERAPEUTIC METHODS - - -	121
VII.	SOME GENERAL DISEASES - - -	157
VIII.	SOME LOCAL DISEASES - - -	186
	APPENDIX - - -	211





## LIST OF ILLUSTRATIONS

COMPLETE INSTALLATION FOR HIGH-FREQUENCY  
TREATMENT, COMPRISING SWITCHBOARD  
WITH DIPPER - BREAK, COIL, OUDIN-DEAN  
RESONATER, AND COUCH FOR AUTO-CON-  
DENSATION - - - *Frontispiece*

FIG.	PAGE
1. GALVANIC CELL - - - -	14
2. DIAGRAM ILLUSTRATING THE ANALOGY OF THE FLOW OF WATER TO A CURRENT OF ELECTRICITY - - - -	17
3. ARRANGEMENT OF CELLS IN SERIES -	19
4. ARRANGEMENT OF CELLS IN PARALLEL -	20
5. LECLANCHÉ CELL - - - -	21
6. BICHROMATE BATTERY - - - -	22
7. ACCUMULATOR OR SECONDARY BATTERY -	24
8. BATTERY OF PORTABLE ACCUMULATORS -	25
9. VOLTMETER - - - -	27
10. DYNAMO FOR CHARGING ACCUMULATORS -	29
11. CONTINUOUS CURRENT TRANSFORMER -	31
12. SCHEME FOR UTILIZING THE ALTERNATING MAINS - - - -	32

FIG.		PAGE
13.	SYNCHRONOUS INTERRUPTER - -	33
14.	PLAN OF SYNCHRONOUS INTERRUPTER -	34
15.	THE BATTEN RECTIFIER - - -	36
16.	SECTIONAL VIEW OF NODON VALVE -	38
17.	PLAN OF NODON VALVE - - -	39
18.	THE NODON VALVE - - -	41
19.	STATIC MACHINE - - -	42
20.	MUTUAL INDUCTION - - -	48
21.	ELECTRO-MAGNET INDUCTION - -	49
22.	MAGNETO-ELECTRIC INDUCTION - -	49
23.	DIAGRAM OF MAGNETIC FIELD OF INDUC- TION COIL - - - -	50
24.	DIAGRAM OF INDUCTION COIL - -	52
25.	INDUCTION COIL - - - -	53
26.	MERCURY JET INTERRUPTER - -	56
27.	THE MOTOR DIPPER MERCURY BREAK AND SWITCHBOARD - - - -	60
28.	MACKENZIE-DAVIDSON INTERRUPTER -	62
29.	ELECTROLYTIC BREAK - - -	63
30.	WEHNELT INTERRUPTER - - -	64
31.	DIAGRAM OF HERTZ'S COIL - - -	66
32.	OSCILLATION OF FLUID IN A U-SHAPED TUBE - - - -	68
33.	LOUDIN-DEAN RESONATER - - -	70
34.	DOUBLE RESONATER - - -	75
35.	SMALL MODEL RESONATER - - -	77
36.	AUTO-CONDENSATION COUCH - -	79
37.	MILLIAMPEREMETER - - -	81
38.	COUCH FOR AUTO-CONDUCTION - -	82
39.	CAGE FOR AUTO-CONDUCTION - -	83

FIG.	PAGE
40. METAL EFFLEUVER - - -	85
41. BISSERIE'S BRUSH - - -	85
42. TESLA ELECTRODE - - -	86
43. BISSERIE'S GLASS REGULATING ELECTRODE - - -	86
44. THE AUTHOR'S GLASS ELECTRODES -	87
45. ISENTHAL'S HIGH-FREQUENCY COMBINATION - - -	89
46. INDUCTION EXPERIMENTS - - -	95
47. DUCRETET'S TESLA APPARATUS - -	98
48. DIAGRAM OF TESLA'S EXPERIMENT -	103
49. OUDIN'S RESONATER - - -	107
50. D'ARSONVAL'S EXPERIMENT - - -	114
51. HANDLE METAL ELECTRODE - - -	123
52. DIRECT APPLICATION - - -	125
53. UPRIGHT AUTO-CONDUCTION CAGE -	130
54. COLLAPSIBLE AUTO-CONDUCTION CAGE -	131
55. DIAGRAM OF AUTO-CONDENSATION -	135
56. DIAGRAM OF EXPERIMENT OF CONDENSATION - - -	136
57. SCHEME OF AUTO-CONDENSATION WITH ELECTROLYTIC INTERRUPTER - -	137
58. LARGE REGULATING EFFLEUVER - -	139
59. MEDIUM-SIZED EFFLEUVER - - -	139
60. ISENTHAL-LOUDIN RESONATER - -	143
61. GAIFFE'S FORM OF BI-POLAR RESONATER, WITH CONDENSER - - -	145
62. D'ARSONVAL'S BI-POLAR RESONATER -	147
63. GAIFFE'S CONDENSER AND SOLENOID FOR AUTO-CONDENSATION - - -	148

FIG.	PAGE
64. A RECENT GROUP OF HIGH-FREQUENCY APPARATUS WITH SILENCED SPARK-GAP, SUITABLE FOR ALL FORMS OF TREATMENT - - -	151
65. HERSCHELL'S TONGUE ELECTRODE -	152
66. HERSCHELL'S REGULATING HANDLE AND RECTAL ELECTRODE - - -	153
67. PROSTATE, PERINEAL AND URETHRAL ELECTRODES - - -	154
68. DR. DOUMER'S RECTAL EXCITATEUR, AND HANDLE FOR SAME - - -	154
69. GLASS CONDENSER - - -	155
70. VACUUM ELECTRODE FOR EXTERNAL WORK	155
71. EBONITE SPINAL ELECTRODE - -	155
72. A COMPLETE INSTALLATION FOR HIGH-FREQUENCY TREATMENT - <i>To face</i>	156
73. DIAGRAM OF ATONIC DILATATION OF STOMACH - - -	175
74. HÆMORRHOID ELECTRODES - -	195

## REFERENCES

- ALLAN, JAMES : *Trans. West Lond. Med. Chir. Soc.*, 1902.
- APOSTOLI ET BELIOZ : 'Sur l'Action Thérapeutique Générale des Courants Alternatif de Haute Fréquence,' *Archives d'Electr. Méd.*, 1897.
- BATTEN, G. H., M.D. : *Journal of Physical Therapeutics*, June, 1902.
- BOEDEKER : *Weiner Klin.*, October, 1901.
- BOINET ET CAILLOL DE PONCY : *Trans. Soc. Biologie*, 1897.
- BORDIER ET LECOMTE : Soc. de Biologie, 1901.
- BOUNNIET : Congrès Internationale, Paris, 1900.
- COWEN : *Journal Brit. Elec. Therap. Soc.*, 1902.
- CROMBIE AND BOKENHAM : *Lancet*, October 18, 1902.
- D'ARSONVAL : *Annales d'Electrobiologie*, 1893 and 1894.
- D'ARSONVAL : Soc. des Electriciens, April, 1897.
- D'ARSONVAL ET CHARRIN : Soc. de Biologie, 1893.
- DENOYÈS : *Archiv. d'Electr. Méd.*, 1901.
- DOUMER ET OUDIN : *Annales d'Electrobiologie*, 1900.
- FORNUVEAU DE COURMELLES : *Archiv. d'Electr. Méd.*, 1877.
- FREUND : *Brit. Med. Journ.*, October 25, 1902.
- GUILLAUME : Thèse, Paris University, 1901.
- HALL-EDWARDS : *Journal Brit. Elec. Therap. Soc.*, 1902.
- HEDLEY, W. S., M.D. : 'Therapeutic Electricity.'
- HERSCHELL : 'Intragastric Technique.'

- 
- JONES, LEWIS : 'Medical Electricity.'
- LAGRIFFOUL ET DENOYÈS : *Archiv. d'Electr. Med.*, 1900.
- MORTON, W. J. : *Med. Record*, April, 1881.
- REALE E DE RENZI : *Gazetta degli ospedali e delle cliniche*,  
1897.
- STEPHENSON, S., AND WALSH, D. : *Lancet*, January 24, 1903.
- SUDNIK : 'Action Thérapeutique des Courants de Haute  
Fréquence,' *Annales d'Electrobiologie*, May, 1899.
- VINA, G. S. : Congrès d'Electrobiologie, 1899.
- VINAI E VIETTI : *Giornale di elettriciata medica*, December,  
1899.

CHAPTER I  
INTRODUCTION—HISTORY





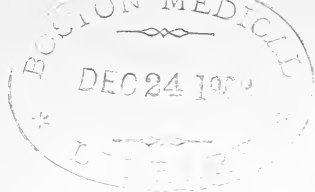

## CHAPTER I

### INTRODUCTION—HISTORY

#### INTRODUCTION

ELECTRICAL currents of high frequency and high potential have been tried, and found of use for many years past in the treatment of some diseases. From a therapeutical standpoint, the honour of their introduction into the practice of medicine is undoubtedly due to D'Arsonval and his fellow-workers. In this country there is an ever-increasing number of medical men who are becoming interested in this form of electricity, and although their introduction into medical practice is of somewhat recent date, already the unscrupulous charlatan and quack has seized upon it for his own. Establishments have been founded by persons

with little knowledge of the apparatus, and still less of the internal apparatus of the unfortunate beings who go to them for treatment. Although it is a fact that, with good apparatus, care, and medical supervision, no harm, but only good, will result, still these currents can exert a powerful influence in disease for harm; it is therefore an absolute necessity that they should be only used by duly qualified medical men, who alone can judge of their physiological effect upon disease. They require just as much skill in administration as that of any other therapeutic measure. The study or a knowledge of their phenomena is an absolute necessity to the present-day practitioner of medicine.

They are no longer regarded as solely of use to produce brilliant physical experiments, but, after several years of careful experimentation on man and animals, have been proved to produce extraordinary and peculiar results in the alleviation of some diseased conditions. There still remain many obscure points re-

---

garding their mode of action, but many of our therapeutical agents are in the same category. In several diseases their use has already been firmly established by an abundance of facts collected from this country and others; and as the field of their utilization becomes enlarged, it is found that they are able to exert a power for good in many conditions little thought of in years past. They are not a 'panacea for all evils the flesh is heir to,' but, on the other hand, by the very nature of their action, being able to produce a general electrification of the cells of the whole body, their effect is that of a general therapeutic agent. A fairly large amount of literature has been published about the method of use and action of these currents, but for the most part it is scattered in many diverse journals, not readily accessible to the busy practitioner. The object of this little book is to give some more or less connected account mainly derived from our own practice, but also collected from any source we have been able to find, and which we trust may

prove of service. It is necessary for a due appreciation of the application of these currents to have a knowledge of what the high-frequency currents are in themselves, the origin of the various researches which have led to their discovery, the laws which govern their production, their physical and chemical properties, the means of measuring and regulating them, and, finally, their physiological properties which have justified their introduction into the practice of medicine. As a certain amount of very elementary electrical knowledge is requisite, I have endeavoured, in a few pages, to very briefly state some of the most useful points.

## HISTORY

In 1842 Professor Joseph Henry of America drew attention to the phenomena accompanying the discharge of a Leyden jar, and instigated researches which led him to suggest that it was oscillatory in character. During the next

twenty years notably Lord Kelvin, in 1855, and later Fedderson, Helmholtz and others, confirmed Henry's original suggestions, and gave the theory of their causation.

As early as the year 1881 William James Morton of New York made known 'A New Induction Current in Medical Electricity,' published in the *Medical Record*, April 2nd and 9th, 1881. He approximated the balls of the exploder of a Holtz machine until the sparks appeared between them, then intercalated his patient in a circuit running from the external plates of the condensers. This oscillatory character of the disruptive spark of the discharge of condensers had not yet been mentioned as capable of being used for increasing the frequency of an alternating current. Morton was thus the first to produce therapeutical high-frequency currents.

For several years these oscillations were being worked at by many patient scientists, but it was not until in 1886 Hertz, and in 1887 Oliver Lodge, published their remarkable

experiments on electric waves that the subject again came before the scientific world. It is interesting to note in passing that they were the forerunners of commercial 'wireless telegraphy.'

In 1879 Ward, assisted by Spottiswoode, stated that the sparks of an induction coil worked by a very rapid rotary interrupter produced 8,000 interruptions per second.

Joubert, in 1889, repeating the experiments of Hertz, remarked that the galvanoscopic foot of the frog did not respond to an enormous number of excitations per second.

In 1890 D'Arsonval, verifying the assertions of Ward and Joubert, proved that beyond a certain number of excitations (5,000 per second) the muscular contraction phenomena decrease in measure as the number of alternations increase; and in order to demonstrate this fact with high frequencies, he constructed an alternator capable of giving 10,000 alternations per second, with a considerable current strength. Finally, in December, 1890, he again took up the same experiments with the devices of

---

Hertz and Oliver Lodge, and showed in April, 1891, a few months after the memorable experiment of Tesla, that a current of high frequency and high potential could with impunity be made to traverse the body, that it even decreased the excitability of the tissues, lowered their arterial tension, and increased the activity of the respiratory combustions (*Annales d'Electrobiologie*, 1893 and 1894).

In 1893 Oudin devised an apparatus, which he prefers to call a 'resonatur,' which greatly increased the tension of the high-frequency currents, and called attention to the fact that the local action was accompanied by general reactions.

Reverting to the experiment of Nikola Tesla, which was published in February, 1891, he made use of alternaters with a multiplicity of poles, and by means of transformers raised the potential to tens of thousands of volts, by which means he was able to demonstrate that the high-frequency and high-potential currents could be passed through one's body with

sufficient electrical energy to light up several incandescent lamps with absolutely no danger to the person.

Quite recently the lay press of this country has been full of the 'cure of cancer' by high-frequency currents. The statements of irresponsible lay writers must naturally be looked upon with the gravest suspicion. During the past year the British Electro-Therapeutic Society (composed of medical men) has had no case of undoubted cancer reported to it as cured by this agency.

Other cases of so-called cancer can be numbered on the fingers of one hand. No microscopical evidence of the various growths has been forthcoming. Undoubtedly a soft malignant growth may be more or less removed by the pressure of an electrode, but the secondary infection is not thereby stopped. I have treated a number of post-operative cases with marked diminution of pain and local growth, but with no arrest of the progress of the disease.



## CHAPTER II

### SOURCE OF ENERGY

ELECTRICAL BATTERIES — TECHNICAL TERMS — PRIMARY  
CELLS—SECONDARY CELLS—ACCUMULATORS—THERMOPILES  
— DYNAMOS — ELECTRIC LIGHT MAINS — RECTIFIERS —  
TRANSFORMERS—THE NODON VALVE—STATIC MACHINE

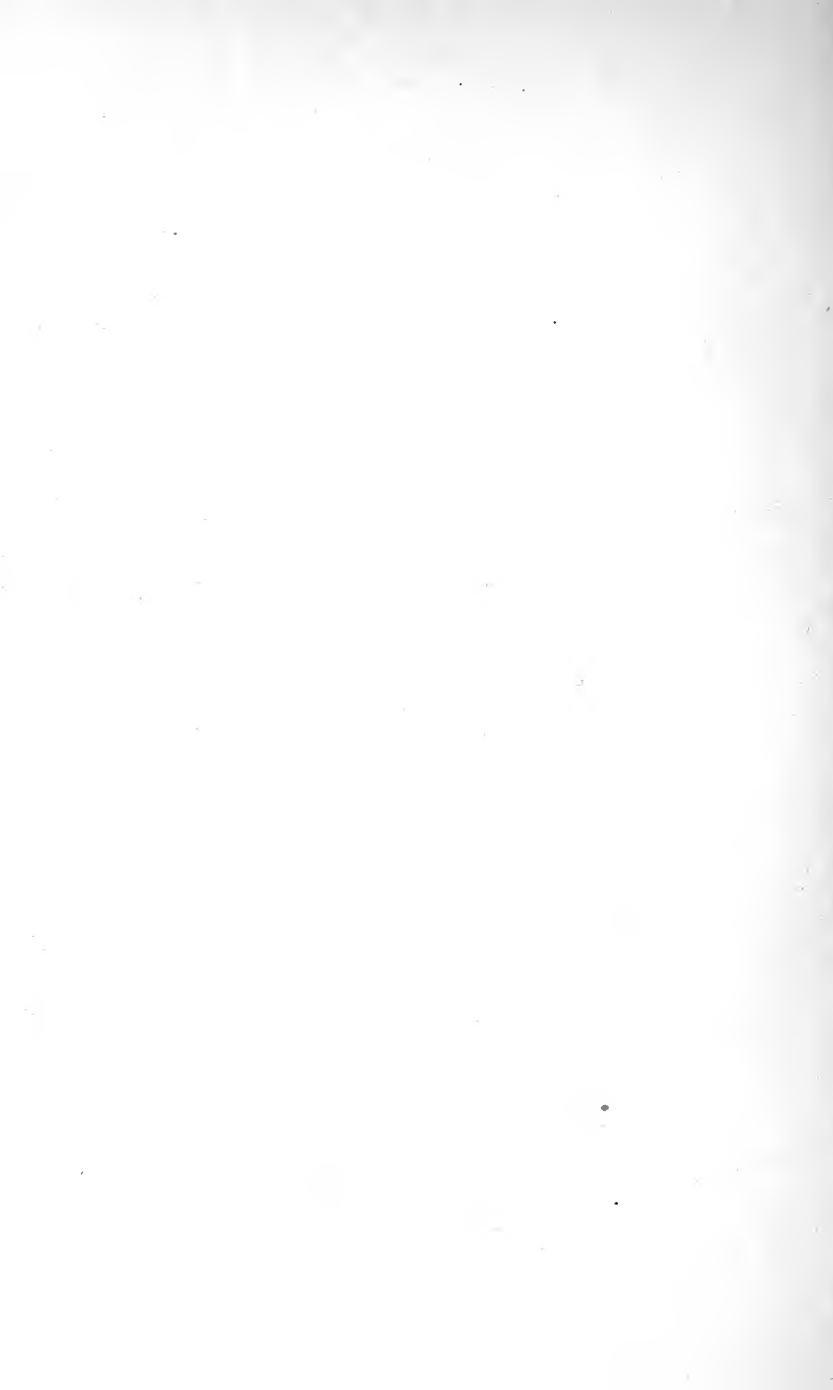

## CHAPTER II

### SOURCE OF ENERGY

THE medical man who purposes using electricity in the practice of his profession must have some slight elementary knowledge of electro-physics, and it is certain that, for his own comfort, the more he understands the more easily he will be able to apply it therapeutically, and the more useful will be his observations of the various results achieved.

Possibly the correct method of introducing such knowledge would be to give an account of the static machine, which is a generator of electricity by friction; but of late years, in this country at least, it has been entirely superseded by other machines, not less costly, but certainly less cumbersome and more adaptable to the medical man's requirements.

ELECTRICAL BATTERIES.—It will only be necessary to mention a few of the various chemical cells used for the production of our electrical current.

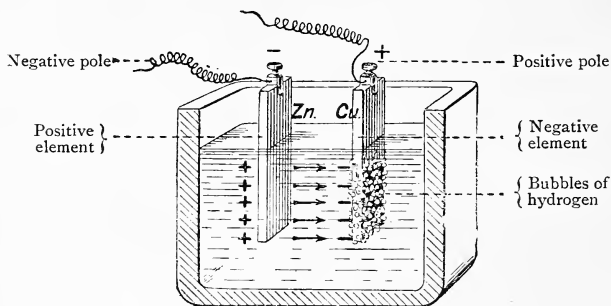

FIG. 1.—GALVANIC CELL.

A galvanic cell consists of two dissimilar metals immersed in various solvent fluids, which are able, by chemical action, to produce an electrical current. The simplest form of cell consists of two different metal plates, say of copper and zinc, partly immersed in a dilute solution of sulphuric acid, one part of acid to seven of water. Owing to the chemical action that takes place the metals become charged with two forms of electricity, the copper with positive and the zinc with negative. If the

plates be 'wired' together above the solution (electrolyte) a current of electricity will flow from the copper through the wire to the zinc, and then through the solution to the copper again; this would be the 'positive' flow. Similarly, a 'negative' current starts from the zinc and flows in the opposite direction. As long as chemical action is maintained a continuous electrical current is produced, the force or power of the current being termed the electro-motive force (E.M.F.), and is dependent solely upon the chemical character of the cell, the maximum E.M.F. being obtained from cells made with zinc and carbon elements.

The length of time during which a given cell will give off current depends on the mass of chemically active material it contains. When the electricity generated is allowed to circulate externally by joining the plates, one notices that on each plate gas bubbles are formed, from the electrolytic decomposition of the water, hydrogen and oxygen being liberated, and these bubbles interfere more or less

with the chemical activity between the liquid and the metals, so that the E.M.F., and with it the tension, tends to rapidly decrease. This action is termed 'polarization,' and can be obviated by several means—one, by surrounding the positive plate, on which the hydrogen bubbles attach themselves, with some oxidizing material, as nitric or chromic acid (separated from the proper electrolyte by a porous material), which liberates oxygen, and thus, with the hydrogen, combines to form water. On this principle depend all so-called Primary Batteries.

Before proceeding further, it may be of service to the reader if we briefly consider the various technical terms used in electricity, and a study of the following figure will explain them.

The unit of the E.M.F. is called a volt, and in a Leclanché cell equal to 1.48, the elements in such a cell being composed of zinc and carbon, is an aqueous solution of chloride of ammonium, the carbon being surrounded by

broken carbon and peroxide of manganese packed in a porous pot.

The unit of resistance is called an ohm, and represents the resistance of a column of mercury at  $32^{\circ}$  F., of one square millimetre

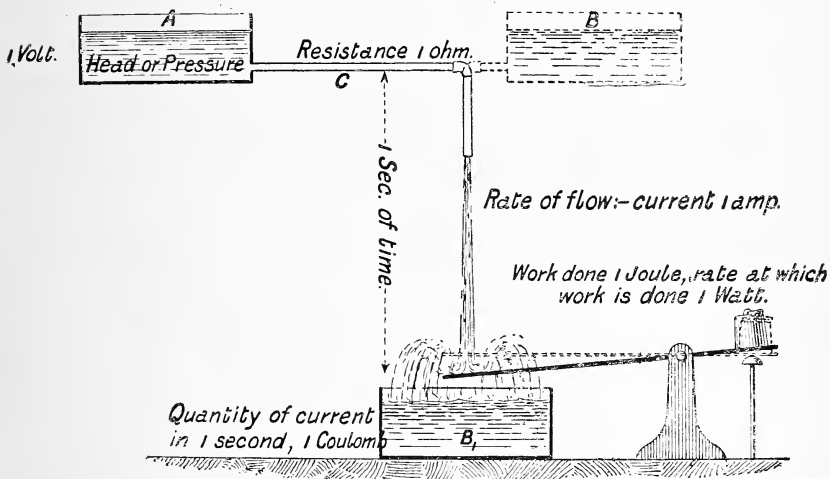

FIG. 2.—DIAGRAM ILLUSTRATING THE ANALOGY OF THE FLOW OF WATER TO A CURRENT OF ELECTRICITY.

in section and 106 c.m. in length, or is equal to 129 yards of copper wire  $\frac{1}{16}$  inch in diameter.

The unit of strength of current is termed an ampère, and is the measure of the rate of flow of a current whose E.M.F. is 1 volt through a circuit whose resistance  $R$  is 1 ohm. For

medical purposes the ampère is inconveniently large, so we measure by milliampères. As will be readily seen by the diagram, these various units are dependent on each other ; thus the greater the voltage the greater the ampèrage, the less the resistance the more the ampères, the current varying directly as the pressure and inversely as the resistance.

Professor Ohm proved that if two of the quantities be known, the third can be found by the following formulæ :

$$\frac{E}{R} = C. \quad \frac{E}{C} = R. \quad R \times C = E.$$

This is what is known as Ohm's law. An easy way of remembering it is to write  $\frac{E}{C \times R}$ . Now, by cancelling any letter, the letter cancelled equals the remainder.

The unit of electrical power is the watt, which is the product of volts and ampères ; there are 746 watts to an electrical horse-power. It is immaterial how the watts are constituted ; for instance, 10 ampères at 100 volts



or 100 ampères at 10 volts would represent the same amount of power—viz., 1,000 watts. The Board of Trade unit, by which the Electric Supply Companies charge for current, equals 1,000 watts for one hour, commonly called watt hours.

To obtain high E.M.F. or large currents it

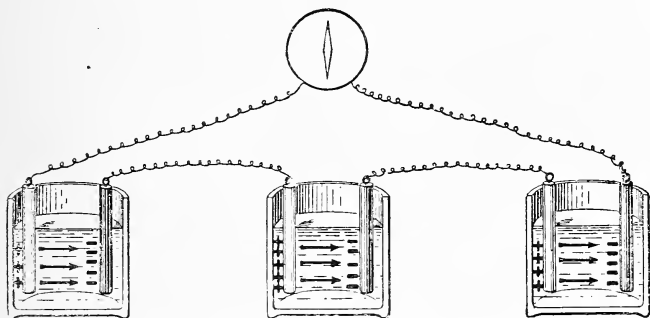

FIG. 3.—ARRANGEMENT OF CELLS IN SERIES.

is necessary to use a combination of several cells. A group of such cells connected up constitutes a primary battery.

There are two chief ways of ‘connecting up’ cells, in series and in parallel. In series we connect each positive to the next negative element of the next cell, thus forming a simple chain. From the free terminals of the battery,

the one negative and the other positive, we obtain an E.M.F. equal to the sum of the E.M.F. of the separate cells. In a Leclanché cell the E.M.F. is 1.5 volts. Four such cells connected in series would have a total E.M.F. equal to 6 volts. If we connect up in parallel

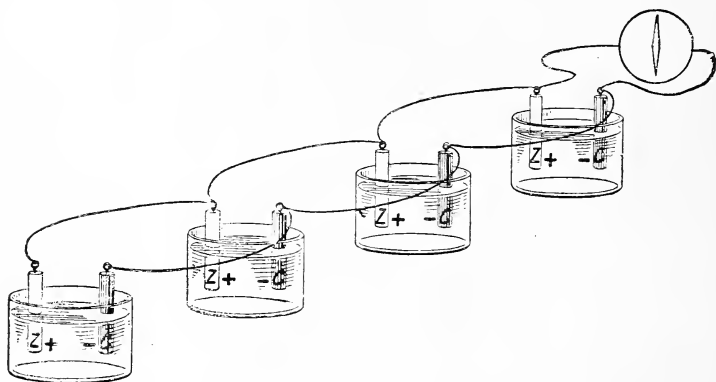

FIG. 4.—ARRANGEMENT OF CELLS IN PARALLEL.

by having all the positives attached to all the negatives, we add together the active surfaces of the elements and reduce the resistance to that of one cell, and practically form one large cell. The E.M.F. does not increase.

Medical men living in remote districts can obtain sufficient power by employing a battery

composed of any of the numerous forms of primary cells.

Suppose we wished to work with an induction coil. We should require, with the Leclanché



FIG. 5.—LECLANCHÉ CELL.

cell, about 20 to 24. These should be connected up in two sets; first, connect up twelve cells in series, zinc of one cell to carbon of next and so on 'in series,' then connect the other twelve in a similar manner. Then con-

nect the two last carbons to one terminal of the coil and the two last zincs to the other.

The excitant fluid is ordinary sal ammoniac and water. They require no attention, only a renewal of the chemical from time to time. Their cost would be about equal to that of a

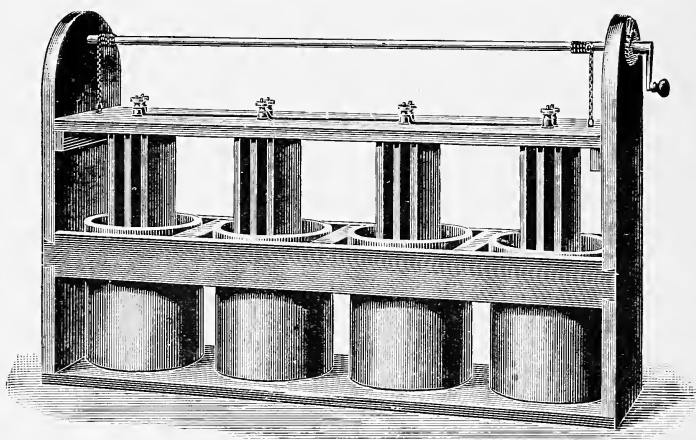

FIG. 6.—BICHROMATE BATTERY.

secondary battery giving 16 volts. They take up a large amount of space, and are, of course, not portable.

Another good form of cell is the bichromate, consisting of zinc and carbon elements in an acid solution, generally bichromate of potash,

the E.M.F. of which equals 1.9 volts ; six quart cells will work an 8-inch induction coil for eight hours. The Grove or modified Bunsen, made with zinc in a solution of sulphuric acid 1 in 10, and carbon in a solution of nitric acid, gives an E.M.F. of 1.1 volts per cell, and would be capable of operating a similar coil for six hours.

The Edison Lalande has as elements zinc and copper ; copper oxide being the depolarizer and caustic potash as an excitant. E.M.F. = 0.78 capacity, according to size.

In a primary cell, when the positive plate or the solution is used up the cell ceases to act until these are renewed.

Having considered primary cells or batteries, we now have to study the secondary cell or so-called accumulator, by which means we are enabled to store up electrical energy. The first efficient one was invented by Planté in 1859.

## ACCUMULATORS OR STORAGE BATTERIES.

ACCUMULATORS OR STORAGE BATTERIES.—In a secondary cell or accumulator the elements are such that after the cell is discharged it can be recharged by passing an electric current through it. In its ordinary form we have many

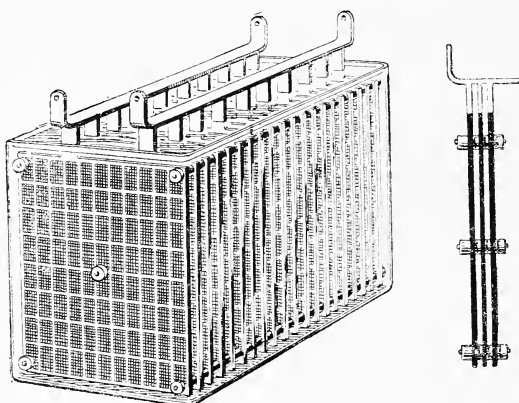

FIG. 7.—ACCUMULATOR OR SECONDARY BATTERY.

plates all of the same metal, as lead in a solution of sulphuric acid and water 1 to 8. The mixture should have a specific gravity of 1.19.

The acid causes a thin layer of the lead to change into sulphate of lead. On passing a current through such a cell, bubbles of oxygen

will appear on the plates attached to the positive (+) pole, and change the sulphate of lead into peroxide of lead ( $\text{PbO}_2$ ); whilst on the plates attached to the negative (-) pole bubbles of hydrogen appear, and reduce the sulphate of lead into a porous, spongy film of metallic lead. When the full chemical action has been

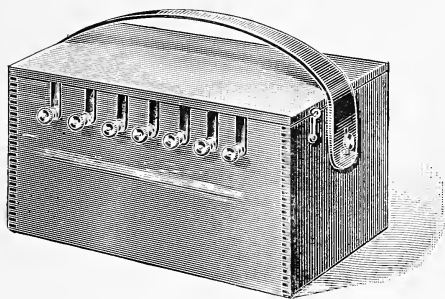

FIG. 8.—BATTERY OF PORTABLE ACCUMULATORS.

produced the gases escape, rendering the solution milky. The accumulator is then fully charged. The passage of the electrical current has effected chemical change and produced two types of plates, which when connected externally by means of a conductor behave somewhat like a primary battery. An electrical current is produced in an opposite direction

to the charging current, the above chemical process is reversed, and continues (whilst discharging) until all the plates are in their original condition as when charged; they then must be recharged. The process may be repeated indefinitely.

The capacity of an accumulator depends on the amount of chemically active material in the acid solution, and this will attain its maximum after the accumulator has been charged and discharged several times, as by these means the layer of active material gradually gets thicker and more porous.

The advantages of accumulators are that they can supply a powerful current at a steady pressure of 2 volts per cell. Up to 6-volt size they are very portable; the capacity is usually expressed in ampère hours—*i.e.*, the number of hours for which the accumulator can be discharged with the current of 1 ampère. If the guaranteed capacity of a certain type of accumulator be of thirty-two ampère hours, at the maximum discharge of 8 ampères, then we



may use the battery at one charge with 2 ampères in sixteen hours, and 1 ampère in thirty-two hours, and so on. Rapidity of discharge injures the cells, and the proper discharging rate should be marked on each accumulator. Short circuiting or flashing by

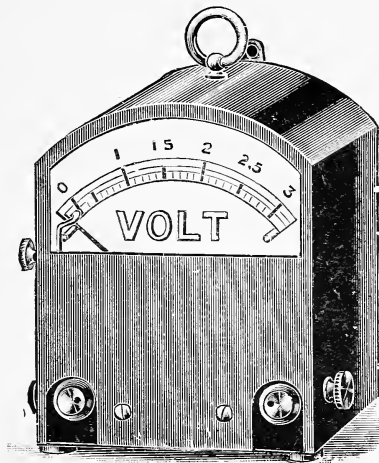

FIG. 9.—VOLTMETER.

connecting both terminals is deleterious. A good accumulator should be able to supply five to ten ampère hours for each pound of lead. The E.M.F. of each cell should be 2 volts, and their internal resistance almost nil.

Their disadvantages may be the difficulty

in country places of getting them charged, and the spilling of the acid by careless handling.

The voltage of accumulators should be tested from time to time by means of a voltmeter (Fig. 9).

The E.M.F. of each cell must not be allowed to sink below 1·8 volts; thus with a six-cell accumulator 10 volts is the limit. In some forms of accumulators buckling of the plates might ensue, and the quantity of active material lessened by disintegration. Even when not in use, it is a good plan to have them charged bi-monthly; if laid aside for a longer time, crystalline sulphate of lead may form, and thus the active surface is diminished.

Owing to loss of acid solution by evaporation, spilling, etc., occasionally it will want replacing, so as to keep the plates well immersed. When the accumulator is full and charged the specific gravity should be 1·25. Charging is best done by dynamos, and if done off the premises a full day should be allowed. If one has a direct current supply in the house, accumulators may

be readily charged by using two or more thirty-two candle-power lamps to act as a resistance between the main and accumulator.

Accumulators may be charged by means of a primary battery (thermopile), small dynamo

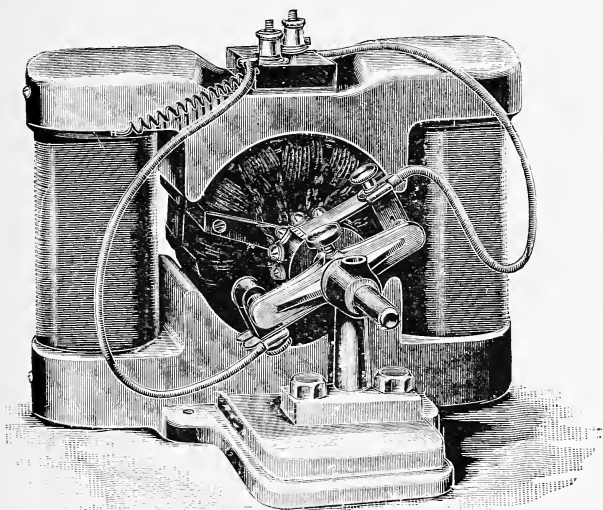

FIG. 10.—DYNAMO FOR CHARGING ACCUMULATORS.

worked by water or other power, or from the direct electric light supply mains.

Thermopiles generate electricity by the heating of two different metals in contact. The heat is applied by means of a gas-flame, which consumes about 40 feet of gas per hour. The

present types are mostly wasteful, and are not in use in this country.

Small dynamos may be used driven by manual labour, or by gas or water power. A medical friend is most successful with this last method.

**ELECTRIC LIGHTING MAINS.**—In the majority of towns the street mains will be available for our initial energy. There are two systems: the continuous or direct, and the alternating or indirect current. The medical man will always find it advisable to have the services of an expert electrician when about to utilize current from the main. The continuous current has the great advantage of being suitable for every purpose for which electricity is required in medicine and surgery. It is the ideal current for our purpose, and its use is accomplished by means of interposing between supply and coil a resistance, or rheostat, consisting broadly of several high candle-power lamps. One can calculate the requisite amount by Ohm's law. If the current available be one of 100 volts

pressure, and it is intended to work a coil taking 10 ampères at 16 volts, this is equal to the energy consumed by three sixteen candle-power lamps; by using a rheostat of lamps it would be necessary to consume energy at the rate of forty-eight lamps of sixteen candle-power each, whilst a good motor transformer

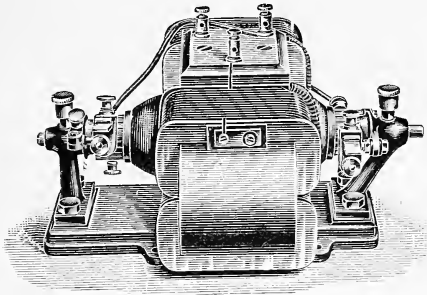

FIG. 11.—CONTINUOUS CURRENT TRANSFORMER.

would only consume current equal to that consumed by four lamps of sixteen candle-power and return 70 per cent. of energy.

A more economical way than by rheostats is the use of a continuous current transformer. The continuous current is a unidirectional current, as that of an accumulator, thermopile or dynamo.

Alternating or indirect currents can be utilized for high-frequency work in several ways, the initial expense in most cases being consider-

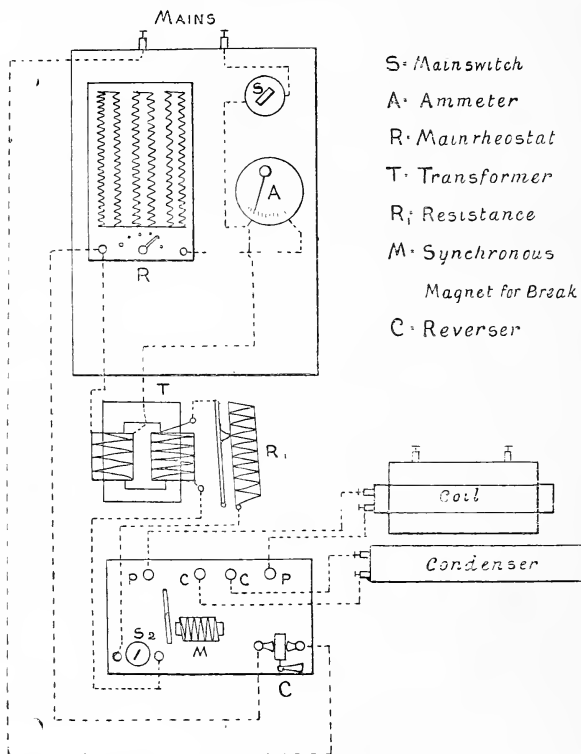

FIG. 12.—SCHEME FOR UTILIZING THE ALTERNATING MAINS.

able. Firstly, by using an alternating current motor directly coupled to a direct current dynamo. Secondly, by transforming the pressure

of the alternating main by a 'step-up transformer' to about 6,000 volts, and then connect-

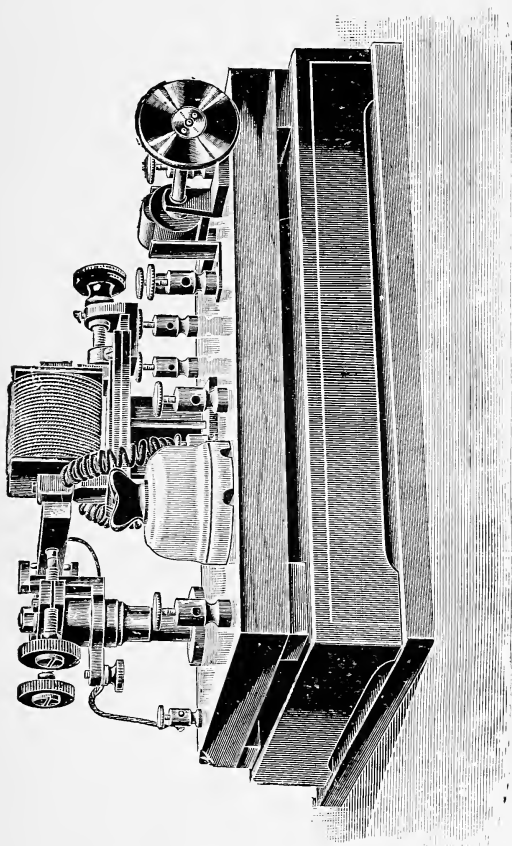

FIG. 13.—SYNCHRONOUS INTERRUPTER.

ing the terminals with a condenser and a spark-gap, which discharges through the primary wire

of a 'Tesla coil,' the secondary of the coil yields an enormous supply of sparks, their length being dependent on construction of coil and strength of initial energy.

Thirdly, by a method of which I have had

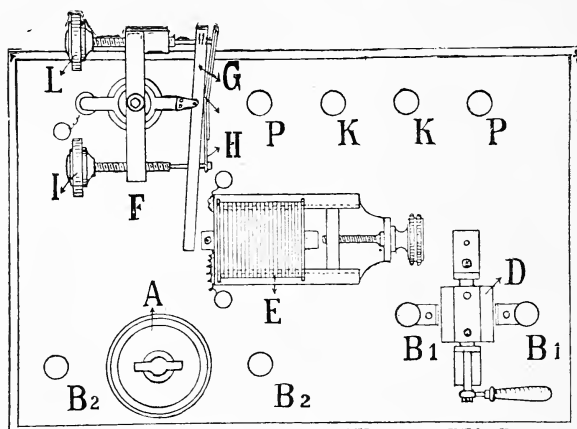

FIG. 14.—PLAN OF SYNCHRONOUS INTERRUPTER.

A, Switch ( $B_2$ ) from transformer and resistance; D, current reverser; E, magnet; F, fixed pillar through which L and I screw adjustments act on spring G; platinum contacts are on the other side from H; PP, primary of coil; KK, condenser.

personal experience, and which is shown in the diagram, Fig. 12.

The alternating main current is split up into two circuits. One such circuit is led through a switch S, an ampèremeter A, and a control-



ling rheostat R to the reverser C on the interrupter board. The other circuit feeds the primary of a transformer T, the secondary of which excites the synchronizing magnet M (after passing through rheostat R<sub>1</sub> and switch S<sub>2</sub>). The primary and condenser of coil are connected to the terminals P and C on interrupter board.

Figs. 13 and 14 show the elevation and plan of the synchronous interrupter which has worked successfully in my hands for several years. A part of my work has been done under these conditions, and I can speak highly of the great convenience from every point of view.

Fourthly, by means of a rectifier, a typical one being that invented by Dr. G. B. Batten and Mr. Sutton, and fully described by the former in the *Transactions* of the British Electro-Therapeutic Society, 1902. This machine, the outcome of much experiment, furnishes a greatly-needed device for obtaining direct currents to those possessing alternating supply mains. Accumulators may be charged

and coils worked direct from it, and it also furnishes a current of therapeutic value. Being vibratory in its only mechanical movement, no running up to speed is necessary. It starts automatically, responding instantly to the switch and working equally well on circuits

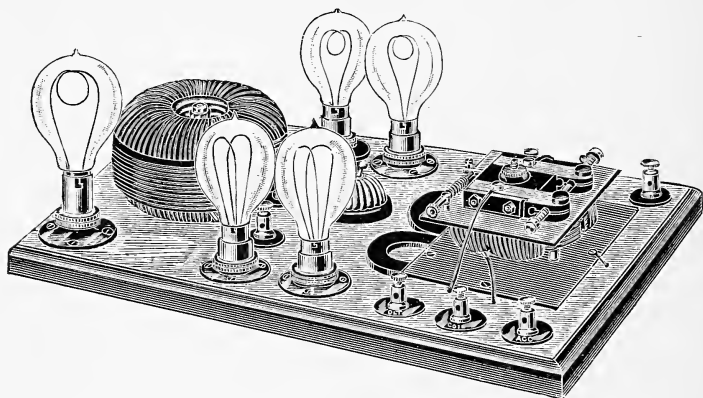

FIG. 15.—THE BATTEN RECTIFIER.

of all frequencies. Owing to transforming down to the voltage required, greater economy of electrical energy is obtained than is possible in charging accumulators on a direct current circuit through lamp resistances. Consider the charging of a 100-volt accumulator: On a 100-volt direct current circuit, taking 5 ampères at

a voltage at the accumulator terminals of 15 volts, 75 watts of this energy would be utilized in charging the cell, the remaining 425 watts being dissipated in heat. With the 'Batten' Rectifier, the voltage is transformed down to 15 volts, and, with the addition of 10 per cent. for transformation and other losses (a liberal allowance in this case), 82.5 watts would be the total rate of consumption of energy. It will thus be seen that instead of dissipating  $5\frac{1}{2}$  units in order to obtain 1, only  $\frac{1}{10}$ th of a unit is needed beyond that necessary for the work to be done, which, on comparison, shows a ratio of 5 to 1 in the two cases—viz., it is five times cheaper to charge from the rectifier than from lamps in circuit.

Most makers recommend for the alternating main a motor dynamo, but for those practitioners who are already 'on' the alternating main and possess a good 12-inch coil, and where ease and convenience in working is an object, the above plan will answer well, with a fair amount of comprehension.

The latest transformer is the Nodon valve, which, as far as its application for medical purposes is concerned, represents undoubtedly the solution of a most important practical problem.

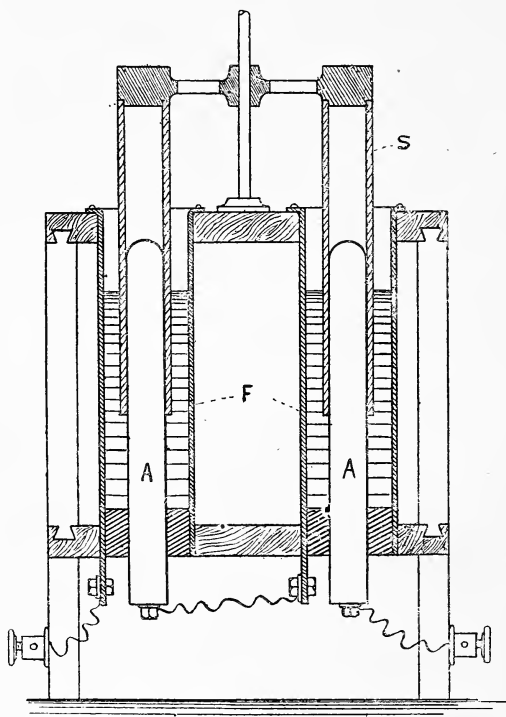

FIG. 16.—SECTIONAL VIEW OF NODON VALVE.

The valve transforms alternating current into continuous current quite independent of

periodicity and — within certain limits — of pressure.

Its construction, as seen from the sectional view given opposite, is ideally simple, and in striking contrast to the unavoidable complication of rectifiers, motor-generators, and the like.

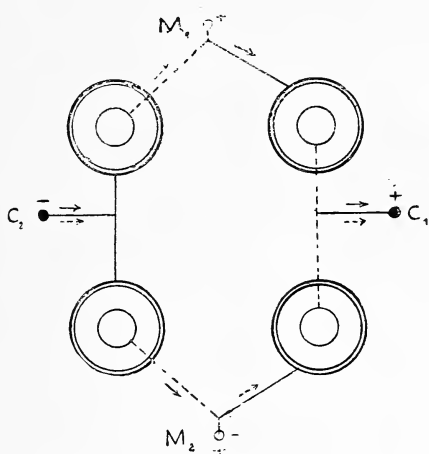

FIG. 17.—PLAN OF NODON VALVE.

An iron-containing vessel (F), with a central rod of an alloy of aluminium and zinc (A), and a solution of phosphate of ammonium.

Four such cells suitably combined, as shown in Fig. 17, when fed with alternating current only, permit the passage of this current in a certain

direction only, so that a unidirectional current will result in the utilization circuit.

The explanation is found in the fact that when a positive current flows from the aluminium to the iron electrode an instantaneous formation of a film of phosphate of aluminium and of zinc, of alumina and of oxide of zinc, takes place at A, which film presents such an enormous resistance to the passage of the current that the latter cannot flow at all in this direction. As soon as the current reverses and flows from F to A, this resisting film is reduced, and the current flows freely.

When a valve has not been operating for several hours, the insulating film should be re-formed. This is effected by simply inserting a resistance between valve and mains for a few seconds, similar to the operation of starting a motor.

The efficiency of the arrangement is about 75 per cent.—*i.e.*, the available working pressure of the valve is about 25 per cent. below that of the supply circuit.

The cells, during work, slowly heat up to  $50^{\circ}$  Centigrade, which will not necessitate any special precautions in any of the applica-

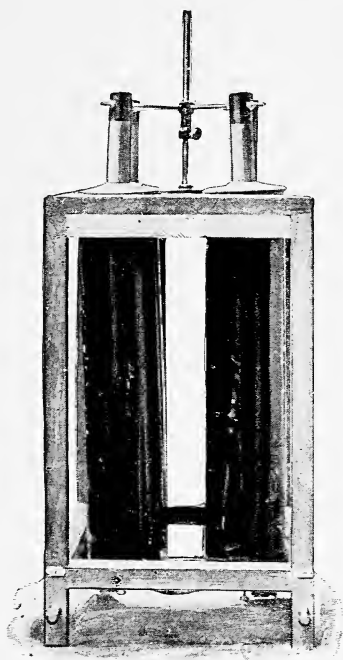

FIG. 18.—THE NODON VALVE.

tions of the valve with which we are concerned.

Neither electrodes nor electrolyte require frequent renewal, and the apparatus may thus

be placed at a distance from the point of utilization.

When the supply pressure is above 140 volts, then a combination of valves has to be employed,

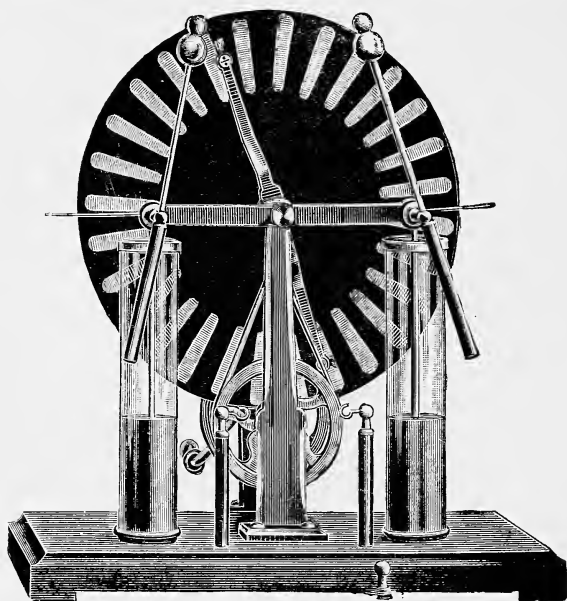

FIG. 19.—STATIC MACHINE.

or a potentiometer rheostat; finally, a small transformer of the ratio 2 : 1 may be advantageously inserted between valve and mains.

With an alternating main of 110 volts the



'Wehnelt' electrolytic interrupter may be used satisfactorily (see Chapter III.).

Static machines may be used for the production of high-frequency currents, but to be of any practical value must be of such dimensions as will give a spark of not less than 12 inches long. They produce electricity by friction, and generally have to be driven by a motor. As will be seen by Fig. 19, such a machine would consist of eight or more pairs of glass or ebonite discs 24 inches or more in diameter, mounted on a fixed horizontal spindle in such a way that they may be rotated in opposite directions. The revolving discs have attached to the outer surface of each strips of tinfoil or sectors; attached to the central spindle at right angles to each other are curved conducting-rods, having at their ends fine wire-brushes, which just touch the rotating sectors. Two forks, termed collectors, are provided with combs directed towards the rotating discs, and fixed at an angle of  $45^\circ$  to the brush-rods. The combs are supported on insulated pillars, and are con-

nected to the discharging electrodes. For certain purposes a Leyden jar may be connected to each set of collectors. These machines are self-exciting. They are seldom recommended for our purpose, as the vagaries of our climate are often adverse to their efficient working. Damp being their greatest enemy, they are often enclosed in glass cases. The motive power to work them may be derived from manual labour, an electric motor, hot air or gas engine, or small water motor from the usual house supply. Two of the best forms of static machines are the Wimshurst and the Toepler-Holtz.

The advantage of such machines is that they are in themselves generators of electrical energy, and independent of dynamo or battery.

## CHAPTER III

### THE APPARATUS

INDUCTION COILS—INTERRUPTERS—THE MERCURY JET—  
THE DIPPER MERCURY—THE WEHNELT—THE MACKENZIE  
DAVIDSON—WHAT IS A H.F. CURRENT?—RESONATORS, OUDIN-  
DEAN—ISENTHAL MODEL—DOUBLE RESONATOR—SMALL  
MODEL RESONATOR—COUCH FOR CONDENSATION—MILLI-  
AMPÈREMETER—CAGE FOR AUTO-CONDUCTION—ELEC-  
TRODES FOR 'EFFLEUVE'—METAL—GLASS VACUUM



## CHAPTER III

### THE APPARATUS

#### INDUCTION OR RHUMKORFF COIL.

HAVING obtained our initial energy at a low pressure (E.M.F.), it is necessary to transform it to one of high potential ; for this purpose we use an induction coil. Faraday, in 1832, first discovered its principles, which are those of electro-magnetic induction.

The first of these principles is that if one brings two entirely separate and distinct circuits near to each other, but not in contact, as in Fig. 20, by passing a current through the one, by mutual induction an electric current is produced in the opposite direction in the other. In the figure to the left is the primary current and primary circuit, whilst on the right side is the secondary current and secondary circuit.

If we suddenly 'break' the primary circuit, a secondary current is for the moment induced in the secondary circuit, but now it is in the same direction. If this 'break and make' is done with extreme rapidity we shall induce currents which are continually changing their direction, therefore an alternating current. According to

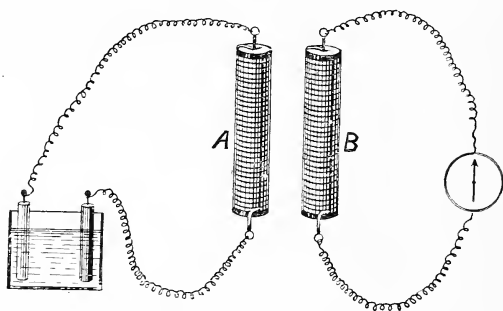

FIG. 20.—MUTUAL INDUCTION.

Lenz's law, an induced current always has a direction opposite to the cause which produces it.

The second principle is that by approaching or withdrawing a magnet to or from a closed metallic circuit, a current is thus induced in the latter (Fig. 20).

The third principle is that a bar of soft, non-

magnetic iron will become a powerful electro-magnet if placed near an electric current, and

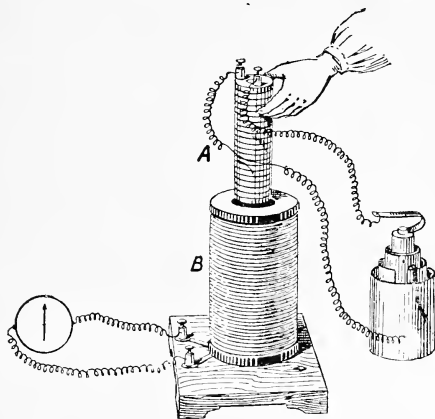

FIG. 21.—ELECTRO-MAGNET INDUCTION.

will remain magnetic as long as the current lasts.

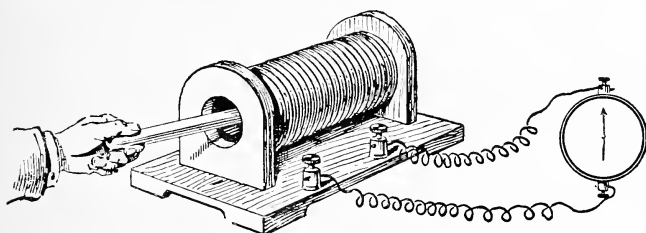

FIG. 22.—MAGNETO-ELECTRIC INDUCTION.

The central core of a Rhumkorff coil (*aa*), Fig. 23, consists of a cylindrical bundle of

thin, soft iron wires, bound together and thoroughly insulated by being impregnated with paraffin wax, and the whole is bound together with tapes. Around this core is wound the primary circuit (*bb*), consisting of a

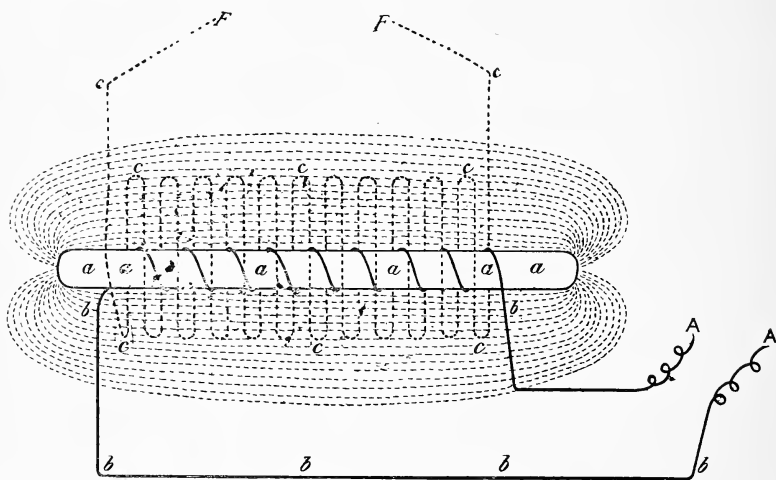

FIG. 23.—DIAGRAM OF MAGNETIC FIELD OF INDUCTION COIL.

comparatively short length of stout silk-covered copper wire (No. 22 B.W.G.), the whole being insulated with paraffin wax, and when cool pushed into a properly-fitting ebonite tube, to thoroughly insulate it from the secondary circuit (*ccc*). Directly the current is passed through



this primary circuit, the iron core becomes magnetized and emits lines of magnetic influence, termed magnetic flux, shown in the diagram as horizontal dotted lines.

The secondary coil consists of many turns of very fine insulated copper wire (No. 36 B.W.G.) wound around the primary, and thoroughly saturated in paraffin wax. For the usual size coil for high-frequency purposes the wire is wound on in thin sections, each section separated from the next by a thin ebonite disc. The wire ends are soldered together, and the whole secondary is waxed in and finished with an ebonite cover. The windings of the secondary coil ( $KK$ , Fig. 24) are continually being impregnated by the flux. In the primary circuit the E.M.F. remains unaltered, but the E.M.F. of the secondary is vastly increased for the following reasons :

The great number of the secondary windings being charged frequently by the magnetic field, the more intense becomes the pressure or voltage in them. The suddenness and rapidity

of the interruptions constantly magnetizing and demagnetizing the iron core results in the induction of currents in the secondary circuit. The current is in a measure decreased by the

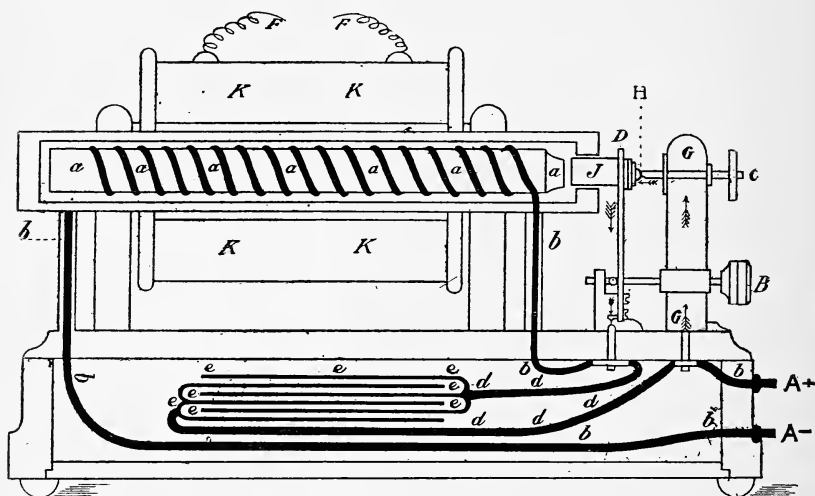

FIG. 24.—DIAGRAM OF INDUCTION COIL.

*a*, Central core; *b*, primary circuit closed; *KK*, secondary circuit; *eee*, condenser; *J*, Hammer break closed at *H*; *D*, spring; *C*, coarse adjustment; *B*, fine adjustment of spring; *H*, platinum contacts.

constant change of its direction. It has already been stated that the making and breaking of the primary circuit induces alternating currents in the secondary, and it is also a fact that the

breaking of the primary circuit will momentarily produce by induction a slight current in the opposite direction, called self-induction. In order to absorb this self-induced current 'condensers' (*eee*, Fig. 24) are used. A condenser consists

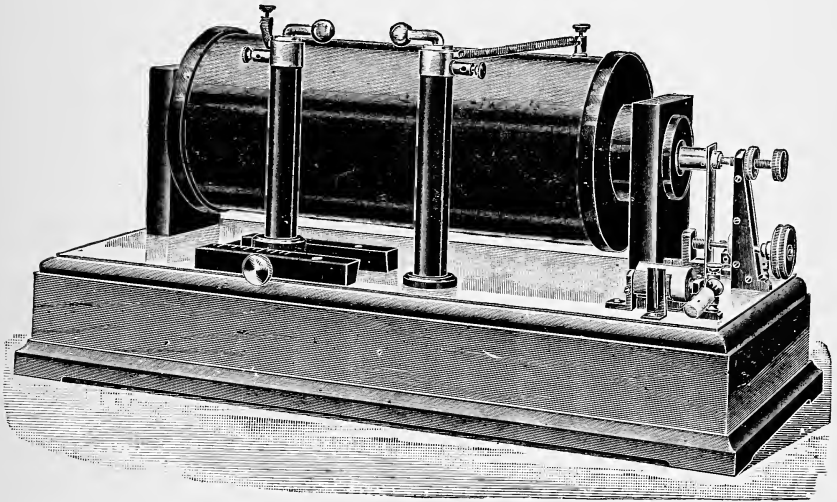

FIG. 25.—INDUCTION COIL.

of several layers of tinfoil separated by sheets of paraffined parchment, the alternate sheets of the tinfoil being attached to one another. The current absorbed by the condenser is discharged a moment later through the primary coil, thus creating a current in the opposite

direction to the initial current, and consequently demagnetizing the core, this greatly adding to the efficiency of the coil.

A 12-inch coil without condenser will barely spark 2 inches.

High-frequency currents may be produced with a 6-inch coil, but the best results can only be obtained with one of 12 inches or more.

The old form interrupter, consisting of a mechanical hammer (J, Fig. 24), is unsuitable for large coils, as it does not allow of much adjustment in either the frequency or suddenness of interruption.

When used, the platinum contacts (H) should be filed from time to time to secure evenness, and the finer adjustment should be done by the 'spring screw' (B).

The noise produced by these 'old-time' interrupters is trying both to operator and patient.

Of other interrupters there are many, the mercury jet interrupter, the dipper mercury, the Wehnelt, and the Mackenzie-Davidson

being the chief patterns. They are all good with ordinary use, but for extensive work they all require a certain amount of attention.

### THE JET INTERRUPTER.

Among the great number of mercury and other mechanical interrupters for large induction coils, the mercury jet type, as first introduced into this country by Isenthal and Co., deserves special attention on account of its distinctive features and functions. As regards the latter, the jet not only serves to interrupt and re-establish the current through the primary of the coil in rapid succession, but also to control and to reduce the pressure from the mains.

A glance at the illustration of the break will make this clear. The current through the circuit, such as the primary of the coil, cannot be instantaneously established in its full and final value, but has to rise gradually against the magnetic inertia and self-induction of the core; time is thus of direct influence upon the value which the current will attain,

and this time is determined by the duration of contact in the break. The current may thus be kept at whatever amount may be desired,

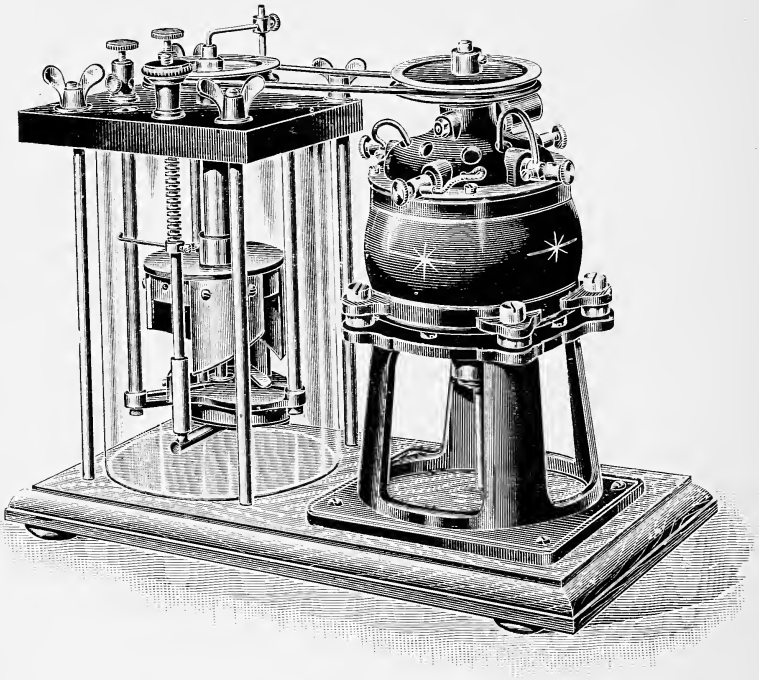

FIG. 26.—MERCURY JET INTERRUPTER.

and this to a certain degree independent of the pressure of the mains; *i.e.*, it will be possible to work with a current of 5 ampères, through the primary, whether the supply pressure be

12 volts from accumulators or 250 volts from the mains. In contradistinction to rheostats, there is thus no wasting of an excess of current, or rather energy as heat, but rather a choking back only, which involves no loss of energy. The rheostats which are used have the purpose of regulation rather than suppression of energy.

The principle of the jet is as follows: By means of a suitable displacement pump, mercury is lifted from the bottom of a vessel and ejected in the form of a fine jet from a small aperture, the level of which may be regulated at will from the above. The mercury and the jet form one pole of the break, the other pole being represented by a number of amalgamated copper contact blades fixed to the circumference of a rotating drum, and which blades are triangular shaped, with their apices downwards. The jet impinges against these contacts during part of their rotation, and thus establishes and breaks contact. To suppress the sparking as much as possible and

insure quick breaks, this contact takes place under an insulating medium, preferably paraffin oil.

Raising the level of the jet aperture naturally increases the time of contact, and thus the current through the coil; this adjustment covers a wide range. Further regulation is possible by varying the speed of the motor and the number and width of the contact blades, so that the instrument becomes available for all pressures and all numbers of interruptions, from 120 to 12,000 per minute. Most important to remember also is the fact that with this interrupter the current through the coil is invariably cut off as soon as the motor comes to a standstill, a very valuable quality when working on high voltages, where a mistake of the nature of leaving the switch on, without the break working, usually means destruction to the coil. The mercury requires cleaning according to the amount of work done. If alcohol be over the mercury, it only requires to be placed under running water for a time. With paraffin



oil used as a covering, it may be cleaned in a few minutes with a little nitric acid.

### THE MOTOR DIPPER MERCURY BREAK.

This break is of the simplest construction. It consists of a small robust motor revolving between double bearings. Its armature is of the ring type. Its brush gear is made with spring brushes and with double field coils. On the end of the spindle is attached a small eccentric, to which is connected a crank gear operating the plunger, which is raised and lowered by the revolving armature. The plunger is held in position by the guide-rod, which runs between two centres. The current to be interrupted is carried to the plunger by a copper flexible spring situate on the top of the motor. The plunger enters the mercury cups, which consist of two portions, an inner one containing the mercury and an outer one containing the di-electric. This break needs but  $1\frac{1}{2}$  pounds of mercury for its work. A side wire is connected to the cup support; the

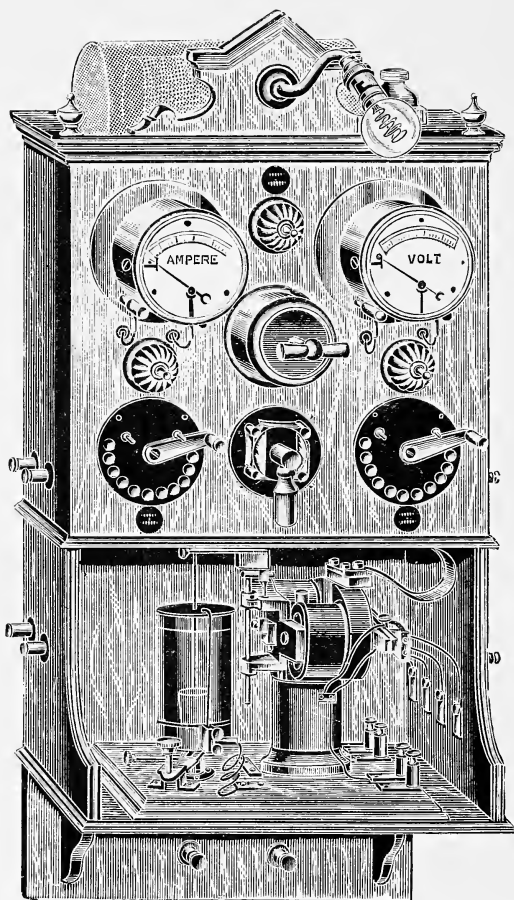

FIG. 27.—THE MOTOR DIPPER MERCURY BREAK AND SWITCHBOARD.

same wire also enters the mercury in order to complete the circuit. A feature of this break

is that the mercury is automatically liberated of its pulverized portions of mercury which are caused by electrolysis. The motor has also a varied range of speed, and can be run at a relatively high speed; the highest speed it attains is 2,000 revolutions per minute, which is sufficient for our purpose. The points to which this interrupter lays claim are, firstly, its reliability to break the current, since the break occurs vertically; secondly, the simplicity of its construction enables it to be easily maintained; thirdly, the small amount of mercury involved.

#### THE MACKENZIE-DAVIDSON MOTOR INTERRUPTER.

This is certainly one of the best of this class of breaks. The construction is fairly simple. It consists of a motor placed in a slanting position on the edge of a vessel filled one-third with mercury and two-thirds with paraffin oil. The axle of the motor is prolonged and projects downwards into the oil, and has attached to

its end a slate disc bearing two metal contacts, which dip into the mercury as the axle revolves. The rapidity of the revolutions can be regulated by a small rheostat (Fig. 28, R), and must be adapted to the E.M.F. of the circuit. These breaks are constructed to work on any voltage.

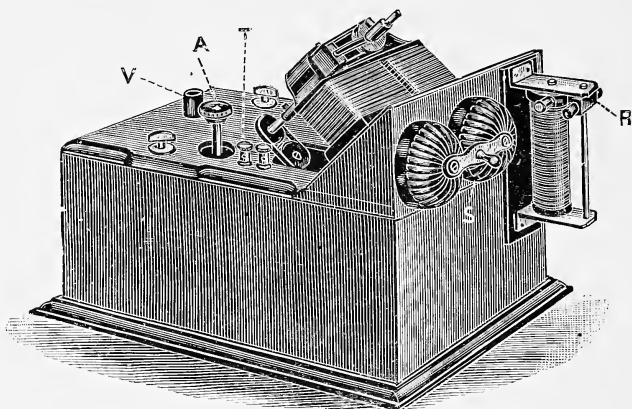

FIG. 28.—MACKENZIE-DAVIDSON INTERRUPTER.

V is for filling the glass vessel; A, the adjustment; T, for the terminals from the electrical source; S, the switch.

#### ELECTROLYTIC BREAK.

The usual form of this break, as invented by Dr. Wehnelt, consists of a glass jar (V) filled

with a dilute solution of sulphuric acid (1—10), in which the two poles (T, G) are plunged. The cathode terminal is a large sheet, or other

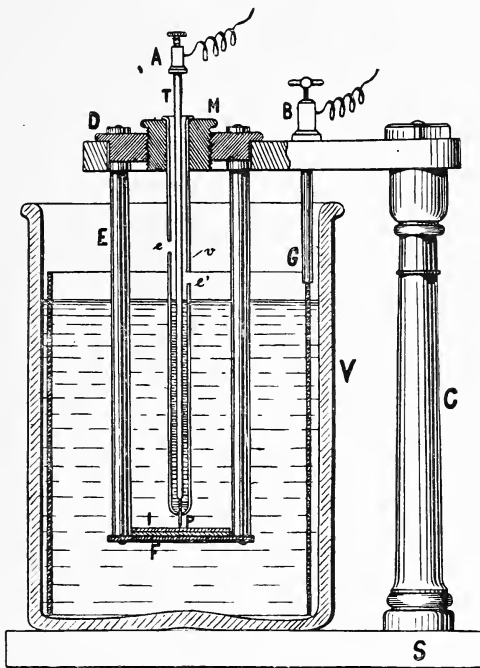

FIG. 29.—ELECTROLYTIC BREAK.

shaped mass of lead (G), whilst the anode is a platinum wire, insulated, except at the extremity of its free end (T), by a sliding glass tube, which allows of a certain amount of

regulation by increasing or decreasing the exposed area of platinum. Owing to the formation and dissipation of gas bubbles at the end of the platinum wire, the interruptions are

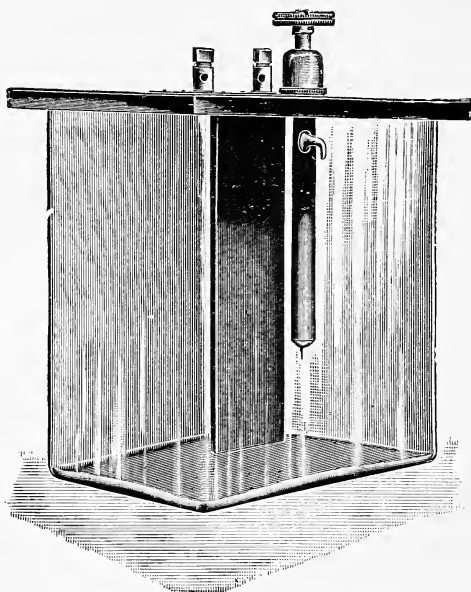

FIG. 30.—WEHNELT INTERRUPTER.

of extreme rapidity. The voltage required for the Wehnelt is somewhat high—24 volts and upwards; but from 40 to 80 volts it seems to give the best results. No condenser is required for the coil. The noise of working precludes

its use in the treatment room unless efficiently muffled. The interruptions cease when the acid solution reaches a certain temperature, so that the glass vessel should be large enough to take a considerable quantity of liquid. If required to work continuously for half an hour or more, the whole vessel may be placed in a tub and surrounded with ice-water. Another method is to have the lead electrode made as a large coiled tube, through which cold water can circulate.

### WHAT IS A HIGH-FREQUENCY CURRENT?

All electrical sources have a certain electromotive force ; all electro-motive forces under certain conditions produce currents or discharges. The character of the current or discharge depends upon the nature of the electromotive force that produces it, and upon the manner of discharging it, whether it be due to resistance, self-induction, or capacity.

When a ball prime conductor of a static machine is made to discharge, it does so in a

disruptive manner or as a spark, which consists of a series of discharges, between the ball and the object at which it discharges. When a condenser as a ball prime conductor, charged to a very high potential, is discharged into a conductor having a certain self-induction and a small resistance, there are produced extremely

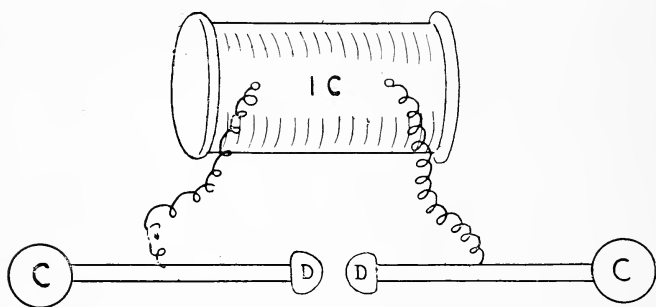

FIG. 31.—DIAGRAM OF HERTZ'S COIL.

rapid isochronous oscillations, that constitute a high-frequency current.

Hertz proved the frequency of the oscillations to be exceedingly high, at times reaching hundreds of millions per second. Hertz, in his experiments on the production of stationary electric waves, made use of an induction coil the terminals of which were wired to two



cylindrical rods, each 5 millimetres in diameter and  $1\frac{1}{2}$  metres in length; at their outer ends were fixed two balls 15 centimetres in diameter, serving as condensers, and at the inner ends of the rods two smaller balls, the gap between being 15 millimetres. Owing to the smallness of the condensers and conductors, the above high-frequency oscillations were produced.

When we remember that the greatest number of vibrations that can be appreciated in the production of sound is 36,000 per second, we must admit that the term 'high frequency' is well merited.

Take as an example a vibrating fixed spring, or fluid in a U-shaped tube. When set in motion it will oscillate for a certain period before coming to a stop if in air, alcohol, or water, which are of slight viscosity, but if we increase the viscosity by placing it in heavy oil, there will be no oscillation, but simply an aperiodic return. In this example we have a slow cycle of visible movement, a dissipation of energy in the form of heat, equal to the work necessary for the production of the phenomena.

So an electric circuit in which a discharge suddenly takes place will follow precisely parallel laws.

The viscosity of the medium corresponds to the resistance of the electric current in ohms. The elasticity of the spring corresponds to the

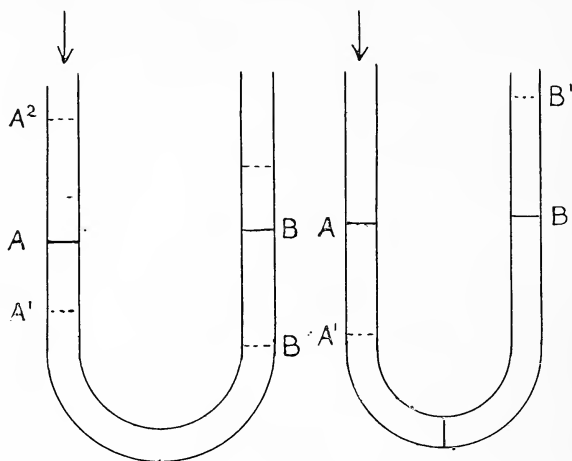

FIG. 32.—OSCILLATION OF FLUID IN A U-SHAPED TUBE.

On the right hand a resistance is put in.

electro-static capacity of the circuit or to its capacity as a condenser, and the displacement to the inductance of the circuit. We therefore shall get an oscillatory or non-oscillatory discharge according to the resistance, as compared with capacity and inductance.

The alternations of an ordinary Rhumkorff coil are about 200 per second, and the E.M.F. of from 10,000 to 200,000 volts, while the alternations of the high-frequency currents are millions per second, and the E.M.F. from 100,000 to 1,000,000 volts, this, of course, depending on the means employed.

#### RESONATORS.

*Oudin-Dean*.—The apparatus illustrated on p. 70 is the apparatus in general use, and the one upon which the greatest amount of data has been collected. The apparatus was first brought to my notice in 1898, and had been in use some little time previous. It is in reality a form of Oudin resonator modified somewhat extensively by the maker. As the illustration depicts, it consists of four portions, the whole being placed on an oak stand, making it a solid and practical machine. The first portion consists of the spark-gap arrangement for receiving the high-tension current from the coil or transformer. Its construction is that of a glass

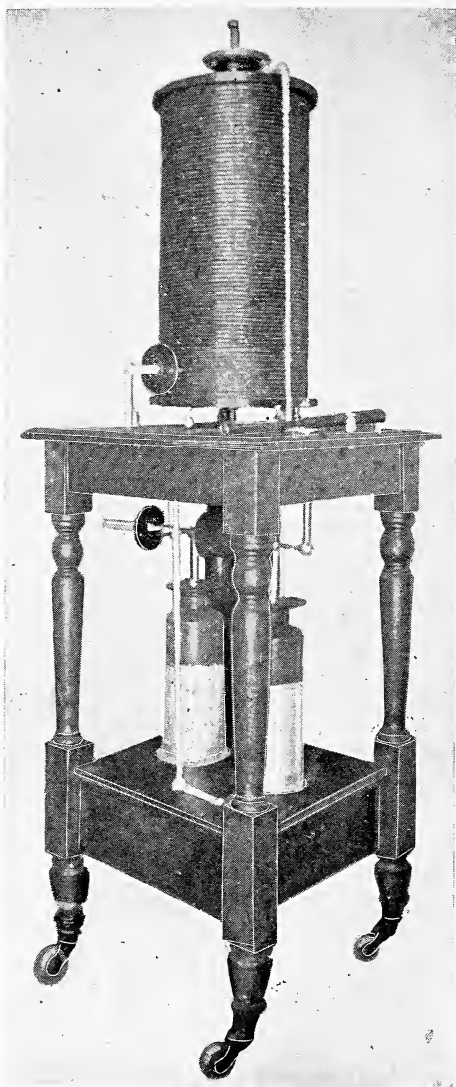

FIG. 33.—OUDIN-DEAN RESONATER.

---

cylinder with open ends, into which are introduced two metallic terminals in the shape of two buttons or balls. These two balls, known as spark-terminals, are attached to two rods which slide within tubes, which are embodied into two insulating discs filling up the ends of the glass cylinder. The whole arrangement is solidly attached to the table and to the mechanism descending into the internal armatures of the condensers. This construction is simple and ingenious, as it allows the spark-gap to be taken down for cleaning with the greatest ease. The operation for doing the same merely consists of separating the spark-points to their greatest distance until they butt on to the discs, and then, by gently pulling one of the rods against the tension of a spring, the glass is released, and can be cleaned thoroughly. Since the operation of cleaning the spark-gap portion, sometimes called 'detonater,' is one of considerable importance and frequent occurrence, a simple and quick device is a boon. In order to close up the spark-gap it is only necessary

to repeat the operation just described, inserting the glass in its proper position.

The second portion consists of the condensers, which in this model are somewhat larger than in most, but in other details it is quite similar to other H.F. machines. The condensers are fitted into spring metal sockets, which are connected to metallic pillars which rise from the lower shelf of the table. These pillars are connected to the mechanism, which taps in its various portions the H.F. solenoid or helix of wire.

The third portion is the H.F. solenoid or helix of wire shown on the lower portion of the drum or cylinder standing on the table. This portion is the one connecting the two external armatures of the Leyden jars, and the one in which the H.F. currents are generated. This solenoid is tapped with a suitable adjustable arm at any desired point.

The fourth portion consists of a long helix of fine wire, which is fixed above the lower solenoid and connected to it at one point. This solenoid

or long helix is the one which resonates to the short or lower one, and which increases the amplitude of the surgings of the high-frequency currents, and which Oudin rightly terms a resonater. This model, in its various modifications, is in every way a reliable, efficient, and a safe form of high-frequency machine, and in its normal rating is capable of generating 350 milliamperes on the lower solenoid, and of giving an effleuve on its upper portion of 6 or more inches in length.

*The Double Resonater* (Fig. 34).—This group of machines is the most powerful we have yet seen, and consists of five portions, as shown in the illustration on p 75.

On the left is seen a form of wall switchboard, to which the current from the mains is brought. In this switchboard the current is separated into several portions. One portion is taken by a shunt circuit to a strong rotary interrupter, which is seen in the recess, and which is controlled by a switch and rheostat. The other portion is taken to the primary of

coil for energizing the transformer. As it is important that the primary current be kept under perfect control, the board is fitted with switches, rheostats, volt and ammeter, and cut-outs, and an effective automatic arrangement for controlling both circuits. The coil seen on the right side of the illustration is a multi-sectional coil, capable of giving a heavy secondary discharge, ranging from 18 to 24 inches. The third portion consists of a form of cabinet containing the condensers and spark-gap; it is further provided with a rail on its top, so that it may be used as a receptacle for the electrodes and other accessories. The current from the coil enters from the back of the cabinet; the H.F. currents from the condensers are taken away to the resonators by the sides of the cabinet, and connected by flexible wires to the terminals on the sides of the tables on which stand the resonators.

These resonators are much larger than those generally used, and may be used together or singly. The objects of this machine are to



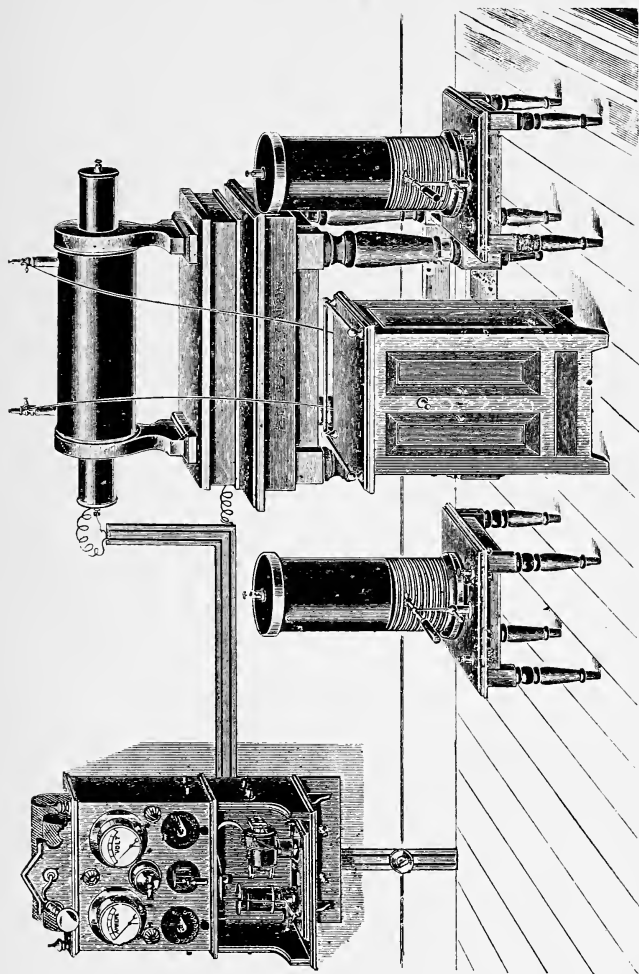

FIG. 34.—DOUBLE RESONATER.

produce a vast electro-static field of alternating sign and an effleuve attaining 12 inches in length. These effects may be used with the auto-condensation couch, in which circumstances the couch constitutes an effleuver.

When the couch is used in this manner, the handles are abandoned. The effleuve may be seen leaping through the insulating cushions as though they were not present, and may even be detected 2 inches above the cushions, if a finger or hand be placed on the cushions whilst the machine is operating in this manner. The effleuve from the second resonator may be used with a large electrode or brush, or it may be taken to a large sheet of metal suspended above the patient; thus he is doubly effleued, and may be said to be in an alternating electro-static field, which penetrates the whole organism on either or both sides alternately. It is also possible, and in many cases preferable, to allow the patient to be put in contact with one half of the machine and to be effleued with the other. The lower sole-

noids may be used singly, in series, parallel, or in a variety of ways, the sum total of which is to double the output of energy available for application to the patient. On high voltage

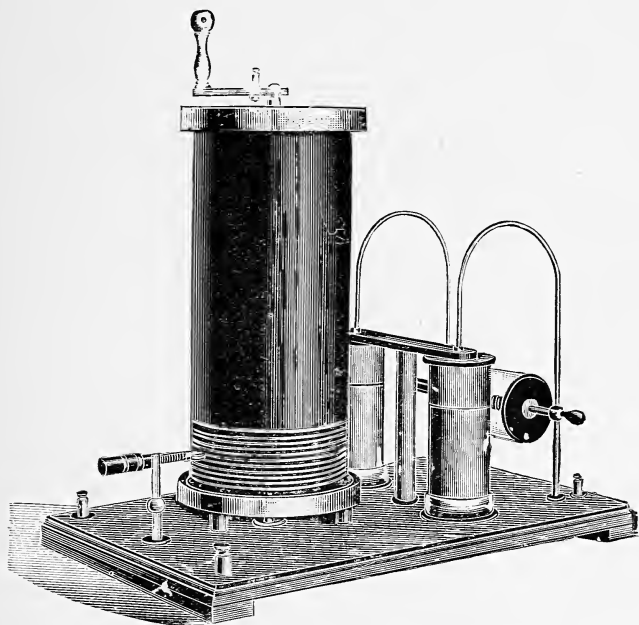

FIG. 35.—SMALL MODEL RESONATOR.

and with suitable interrupter and coil, a current of 1,800 milliampères may be reached.

There are few of these machines in use in England, as they are of recent construction ;

but there are many in use on the Continent, where they are more popular.

The small model shown in Fig. 35 is a type known by the makers as a half-size machine, and is constructed in the same way as the other types, but of smaller dimensions and assembled on a board. The methods used for erecting the parts and its size make it a very compact, portable model. This model works admirably on small induction coils of 6 up to 10 inches spark length. The output of the machine when fully excited reaches 200 milliampères, which may be attained even from battery power. This model is in use by practitioners who make ear, throat, and skin affections their special study, and for the local treatment of small areas. It is not suitable for use with an auto-condensation couch or a solenoid, as its capacity is too small for these accessories.

## THE AUTO-CONDENSATION COUCH.

This piece of apparatus, so valuable in high-frequency applications, appears at first glance to be very ordinary and simple, but the effects obtainable from the couch are in proportion to the care used in its

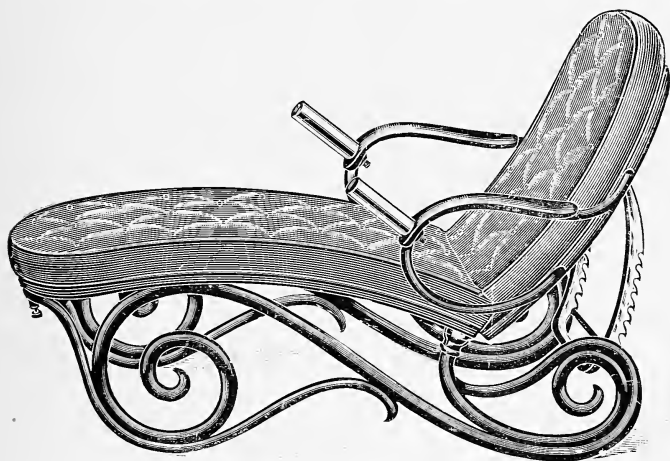

FIG. 36.—AUTO-CONDENSATION COUCH.

construction. Firstly, the couch is usually constructed of beech-wood with a cane seating and covered with a di-electric in the shape of specially-made rubber-filled cushions. A good couch may make or mar cur work in general electrification, since if it is badly constructed a

large portion of our energy may be dissipated and lost to our patient. In the construction of an auto-condensation couch the following precautions are necessary : The couch, as its name implies, is a condenser, and as such must be made as insulating as possible. It must be so devised that the current going direct to the patient and the handles can in no way be short-circuited, as such would mean neutralization and waste to the patient. It is therefore important that every source of dissipation or loss should be avoided. The screws in important parts must be replaced by wood or fibre plugs. The whole of the surface on which the metal sheet is attached should be thoroughly insulated with insulating material. The couch should be coated with a good varnish on which moisture would not gather or deposit. The cushions should so fit the couch that no portion of the patient should be nearer than another, so as to avoid centralization or zone effects, since it must not be forgotten that only that portion of the plate is active that is balanced or covered

by the patient, and capacities in condensers are the all-important factors. Finally, a couch should be made appropriable to the generators supplying it. It is with the couch that the greatest dosage may be given. It is therefore of paramount importance to have a well-made couch.

### MILLIAMPEREMETER.

This apparatus constitutes the only means of indicating to us the exact amount of current

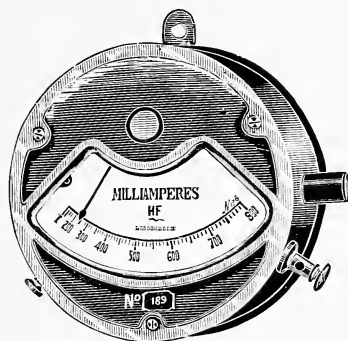

FIG. 37.—MILLIAMPEREMETER.

reaching our patient. The instrument is of special construction, and is known as a hot wire instrument or universal galvanometer. The principle is that of the effect of a current of electricity on a highly resisting medium,

which in this instance is a fine metallic wire, said to be made of an alloy of platinum and iridium. The instrument is graduated from 100 to 700 or 1,000 milliampères.

When 100 or more milliampères are passing over the resisting wire it becomes hot, and the

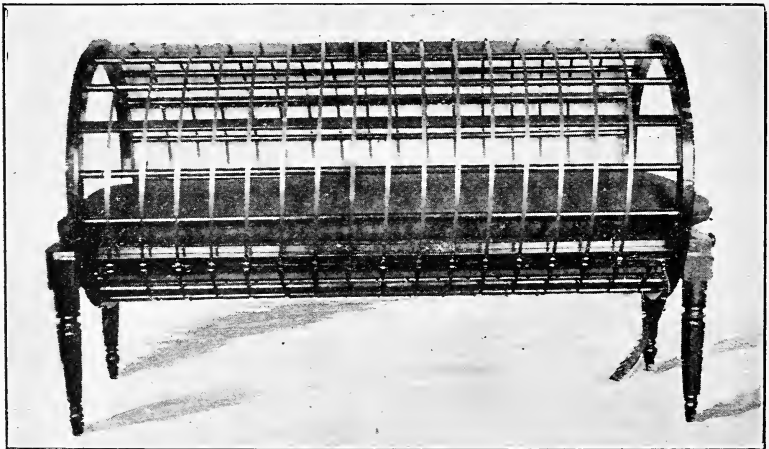

FIG. 38.—COUCH FOR AUTO-CONDUCTION.

effect of such heat is to cause it to expand, and thereby increase in length; this change in length is transmitted by simple mechanism to the pointer, which moves with the changes in the length of the wire.

The degrees are therefore those of heat



translated into fractions of an ampère, and may be considered as an exact measure of the

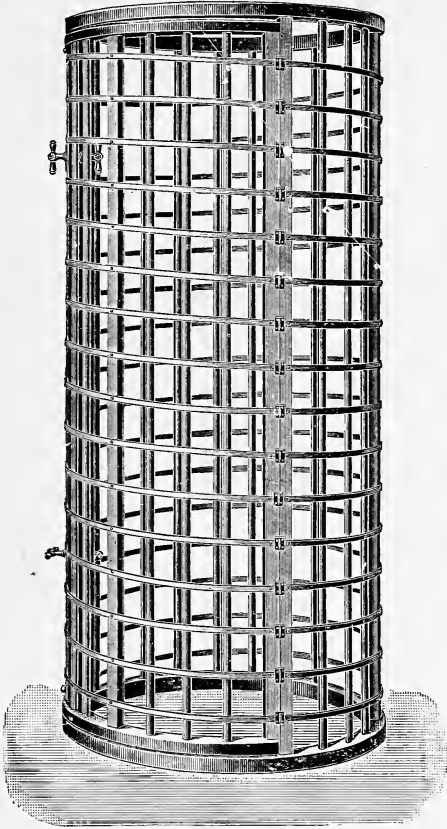

FIG. 39.—CAGE FOR AUTO-CONDUCTION.

intensity of current passing in our external circuit.

In principle they do not differ from those used by the commercial world for alternating currents, and are therefore beyond suspicion and sufficiently accurate for our purpose. The only difference in construction from those of the commercial type is due to the high potential at which they are used as compared with commercial currents.

#### CAGE FOR AUTO-CONDUCTION.

The use of this cage (see Fig. 39) is explained in Chapter VI.

#### EFFLEUVE OR BRUSH DISCHARGE.

An effleuve or electrode for applying high-frequency currents to a specified area consists of a piece of metal, generally cylindrical in form, and furnished on its upper surface with a number of fine wires or points (L, Fig. 40), from which the high-frequency discharge leaps to the patient. The nature of the effleuve may be considerably modified by the type of effleuve used; the greater the number of points, the more

thinned will be the effleuve. There is, however, always a certain loss from the edges; it is therefore an advantage to have the plate sunk



FIG. 40.—METAL EFFLEUVER.

into a piece of vulcanite or other insulating substance. There are various regulating devices—thus, putting the metallic brush in a sliding



FIG. 41.—BISSERIE'S BRUSH.

glass tube (Fig. 41), or by having an adjustable spark-gap on the handle (Fig. 43).

### GLASS ELECTRODES.

These electrodes consist of glass tubes shaped according to their purpose, and are used as a resisting medium to retard the ingress of high-frequency currents to the part applied.

The most common consist of a simple

sheath of glass surrounding a metal armature connected with an insulated handle.

Others, however, are made as a hermetically-sealed tube, having fused into its interior one or more wires. Tesla made some for



FIG. 42.—TESLA ELECTRODE

demonstrating his currents, and they are known as Tesla electrodes, having a resisting medium in the rarefied air contained within them. Some are made by utilizing a resistant fluid medium, whilst another form consists of

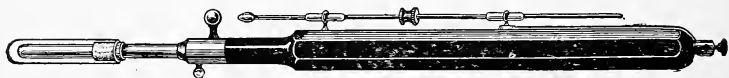

FIG. 43.—BISSERIE'S GLASS REGULATING ELECTRODE.

a double glass with a central armature and vacuum sheath. The most recent are those constructed at my suggestion by Dean, and consist of a series of pieces of thick, hollow glass, shaped to suit the varied forms of applications, and in which is a very high vacuum.

The glass is thick enough to prevent sparking, and thereby preserves the vacuum. These electrodes have a circular band of metal which performs the double part of exciter and contact-maker. They all fit into a universal holder, seen in the lower part of Fig. 44, which carries

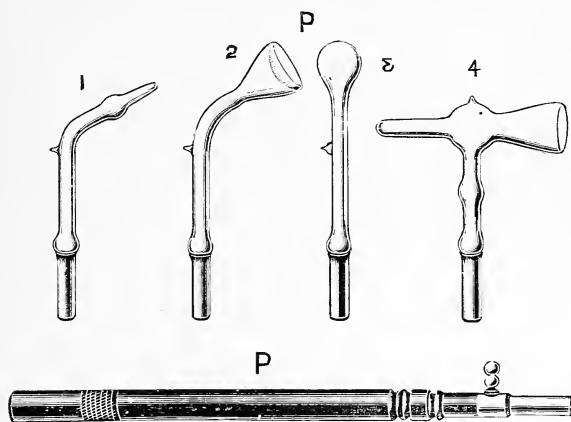

FIG. 44.—THE AUTHOR'S GLASS ELECTRODES.

the connection to the resonator. They can be changed very rapidly, the holder being sprung to keep them from falling out. The various shapes will readily suggest their uses.

Another variety is made with an exhausted glass handle, as were formerly Tesla electrodes.

In my hands they have proved much too frail for extensive use. They have now, however, a thick wall of glass separating the active portion from the handle. For other electrodes see Chapter VIII.

#### X-RAY WORKERS.

The radiographer will see by a perusal of this chapter that, with the addition of a few pieces of mechanism, he will be able to greatly enhance the value of his outfit by being able to treat a number of various diseases, his knowledge of the X rays very materially assisting him in the study of high-frequency currents.

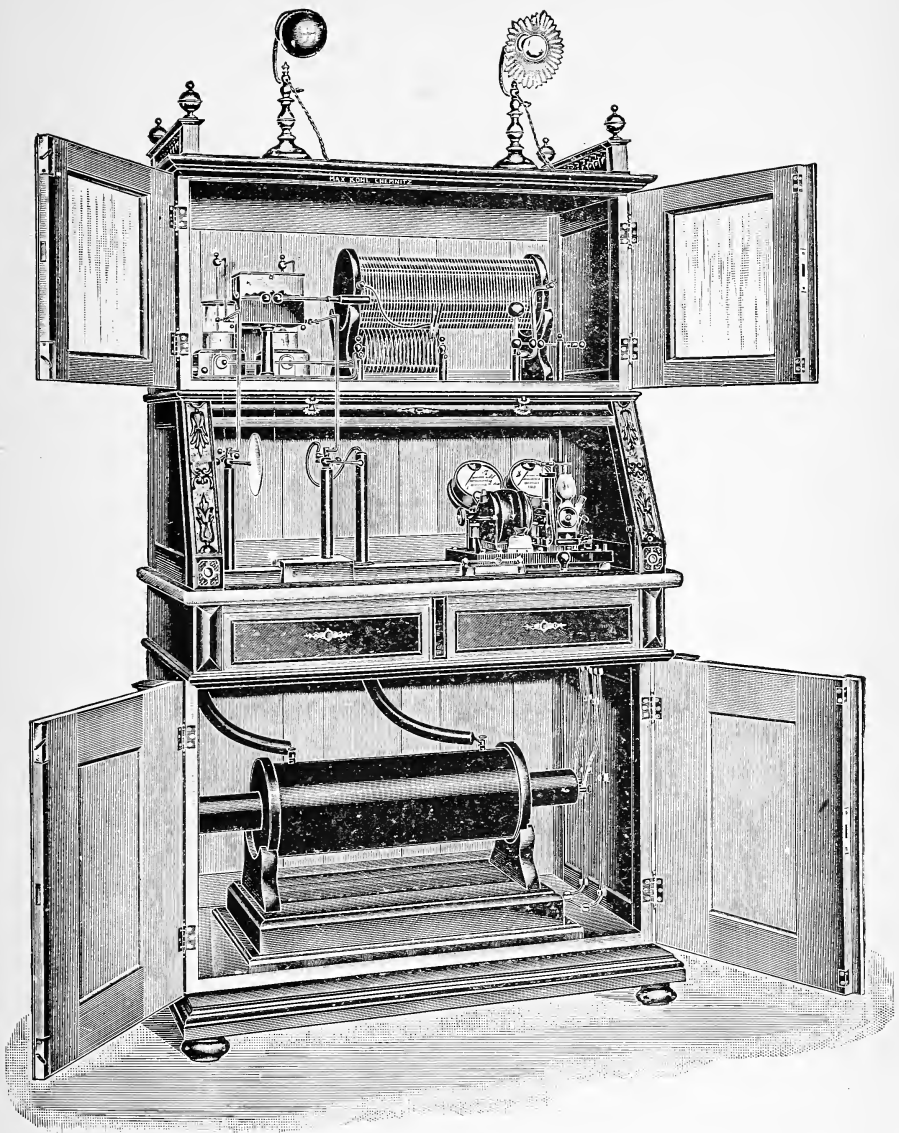

FIG. 45.—ISEENTHAL'S HIGH-FREQUENCY COMBINATION.





## CHAPTER IV

### PHYSICAL PROPERTIES

1. INDUCTION PHENOMENA—2. ELECTRO-STATIC PHENOMENA
- 3. DYNAMIC PHENOMENA—4. RESONANCE PHENOMENA—
5. OUDIN'S RESONATER



## CHAPTER IV

### PHYSICAL PROPERTIES

#### THE PHENOMENA OF HIGH-FREQUENCY CURRENTS FROM A PHYSICAL STANDPOINT.

MANY capable observers have undertaken the research of the properties of these currents, and have furnished us with reliable detail and data concerning their action. We are, however, chiefly indebted to D'Arsonval, Elihu Thompson, Morton, and Tesla for our early information, and perhaps in particular to D'Arsonval and Tesla.

Tesla's apparatus differed somewhat from the form in general use now, but there is a similarity and analogy in their physical properties, which may be classified in the following order :

- Induction effects.
- Electro-static effects.
- Dynamic effects.
- Resonance effects.

Firstly, induction effects may be said to be the most intense in their action, as the apparatus giving rise to them is of a potent nature. Induction is the effect of an electromagnetic flux on a neighbouring body susceptible to an induced magnetic saturation. The degree or intensity of an E.M.F. is proportional to that of the rate of variation of the magnetic changes, or multiplied by the frequency.

It is therefore obvious that one may produce on a body an effect at a high frequency and low tension equal to that of a high tension and low frequency on the same or equivalent mass.

Thus a current of 1 ampère with a frequency of 100,000 would give rise to an effect in one turn of wire which would be equal to a current of 100 ampères of 10 frequencies in 100 similar turns of the same wire. Several very interesting experiments may be made with a length of stout wire wound in the form of a spiral of various sizes and shapes, of which we show a few illustrations taken from the catalogue of E. Ducretet of Paris. Fig. 46

represents a solenoid or spiral of coarse wire (H) connected with the generator (A B), and through or along which are passing alternating currents of high frequency. It will be seen that an incandescent lamp of commercial type will glow to incandescence if placed upon the solenoid or coil of wire. The current flows preferably

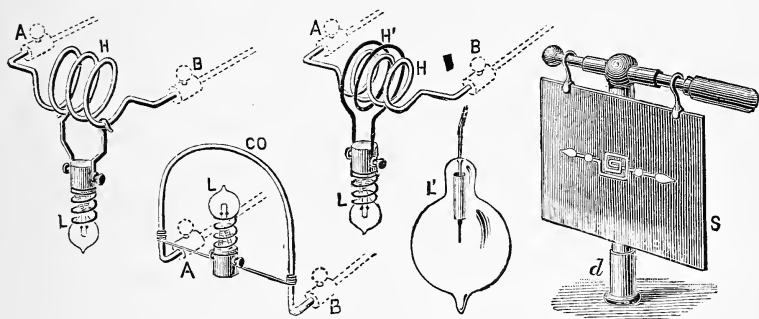

FIG. 46.—INDUCTION EXPERIMENTS.

through A L B, since it is well known that an alternating current gives rise to a considerable back E.M.F. of self-induction, which is in proportion to the degree of frequency. We might vary our experiment by placing the lamp (L) this time within the solenoid (H), when it will be seen to glow again. With powerful currents

it will suffice if the lamp be connected to a single turn of wire surrounding the first-mentioned helix. This is due to the phenomenon of mutual induction.

Again, one might try these mutual induction effects by attaching a lamp of 5 volts to a short length of copper wire (CO) of slight resistance, 0.0007 ohm, and by these means establish the degree of energy present to cause the lamp to burn. Low voltage lamps, being very inefficient, need a deal of current, but by means of continuous current we can ascertain the energy necessary. This will show us that with the coarse wire the intensity necessary to produce the same effect would be in accordance with the following

$$\text{formula: } I = \frac{E}{R} \text{ or } \frac{4}{0.0007} = .6 \text{ ampère.}$$

It will therefore be seen that a lamp of 30 volts and 16 candle-power on the solenoid used for auto-conduction would illuminate to its normal capacity on a single turn of wire.

It is also possible to produce secondary effects of even greater tension than those

before mentioned by the solenoid, and which may be demonstrated in the following way: Take a spiral of fine wire and encage it with a di-electric, such as glass or ebonite, surrounding which are the turns of heavy wire connected to our condensers. The tension of these currents is far too great to rely on the insulating properties of the surrounding air, and the whole thing must be submerged in a bath of oil of paraffin. It is for this reason shut up in glass vessels which are highly resistant in order to increase the di-electric strain. Such an apparatus would, when excited, give rise to sparks of great length.

DESCRIPTION OF A SMALL APPARATUS BY M. E. DUCRETET, REPRESENTED IN FIG. 47, p. 98, FOR SHOWING INDUCTION EXPERIMENTS.—The current induced by a Ruhmkorff coil reaches  $i i$ , and charges the condenser (L). When the difference of potential between the armatures of the condenser is sufficient, a spark bursts out at E. The explosive distance ought to be regulated between the two terminals.

This discharge being of an oscillatory nature, an alternating current at high pressure is established in the primary, which consists of a thick wire transformer (T) (without iron with which

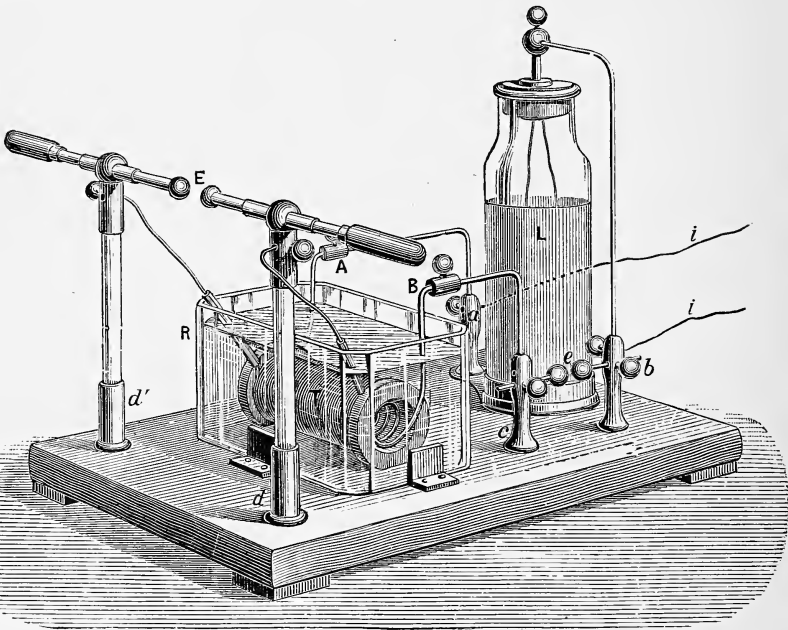

FIG. 47.—E. DUCRETET'S TESLA APPARATUS.

to diminish the self-induction); the secondary circuit of thin wire leads to the rods of the exciter. The electric force of induction in this secondary circuit is so high that one is obliged



to place the transformer (T) in an oil-bath (R). In this manner the sparks are prevented from passing from one coil to another. Sparks of high potency and of high tension are given off at E.

#### ELECTRO-STATIC PROPERTIES.

Most high-frequency apparatus are so constructed that they allow one to produce from them physical phenomena analogous to that obtained from influence or static machines of the Wimshurst type.

In order to demonstrate the electro-static properties, a few simple experiments have been devised. For example, one may connect the two ends of the short solenoid of a H.F. machine to two plates of metal of suitable dimensions, insulated and separated from one another; between two such plates a powerful electro-static field will be generated, the existence of which can be shown by bringing a 'Geissler' or vacuum tube between them, which will be seen to glow as though attached

to the terminals of an induction coil. If a similar plate of glass covered on either side with tinfoil be interposed, and each side have attached to it a wire to which an electric lamp is fixed, it will be seen that the filament will glow, clearly demonstrating the presence of waves of electricity emanating from an electro-static field.

If two cotton-covered wires be attached to a Tesla high-frequency generator, and held parallel and near to one another, streams of sparks will be seen leaping from one to the other.

It is also a common sight to see the two wires connecting the resonator to the transformer glowing with sparks. These do not, however, penetrate the windings of the high-potential transformer or coil, owing to the high degree of resistance and the extra current it generates.

The high-frequency machine whilst in operation causes particles of carbon-metallic dust, or similar matter, to be attracted to it in a like

manner to that of a static machine. It also generates ozone in very considerable quantities, far greater than that of the static machine. In fact, it may be termed the ozonizer *par excellence*. Some eminent French physicists instigated some researches on these matters, and pronounced absolutely in favour of the high-frequency machine. Tesla describes an experiment in this same direction, in which he connects to one secondary terminal of an induction apparatus a metallic sphere connected to a large plate of metal. He then brings in the neighbourhood of the free secondary terminal another metal ball, which, when at a critical distance, is seen to be covered with a multitude of free sparks. If, however, the ball be brought into contact with the free terminal, and the hand brought near it, sparks will be seen to leap from the finger-tips.

Another modification of the same experiment may be achieved by connecting a helix of coarse wire, about 24 inches across, to the external armatures of the Leyden jars. If

another helix of smaller diameter—say, 10 inches—be placed within it, in a plane coinciding with the larger, a circular luminous sheet will be seen to unite the two helices.

### DYNAMIC PROPERTIES.

The high-frequency machine has also considerable dynamic properties; one of the most characteristic is the facility with which the high-frequency currents circulate in an open circuit, particularly when any capacity is present.

Suppose a conductor be connected to the high-frequency machine by the two poles, and in the middle of this conductor a piece of fine wire of high resistance be interposed, on allowing the H.F. currents to circulate, the fine wire will become heated, glow, and perhaps fuse, from overload. Similarly, if a piece of sealing-wax be used to couple the two wires, the current will leap from each wire, generating sufficient heat to fuse the wax.

Tesla also describes another experiment with

his H.F. machine, using the metallic plate and sphere. Between the plate and the apparatus he interposes an induction apparatus connecting the primary winding with the machine. On the secondary windings he connects an incandescent lamp which will illuminate; even

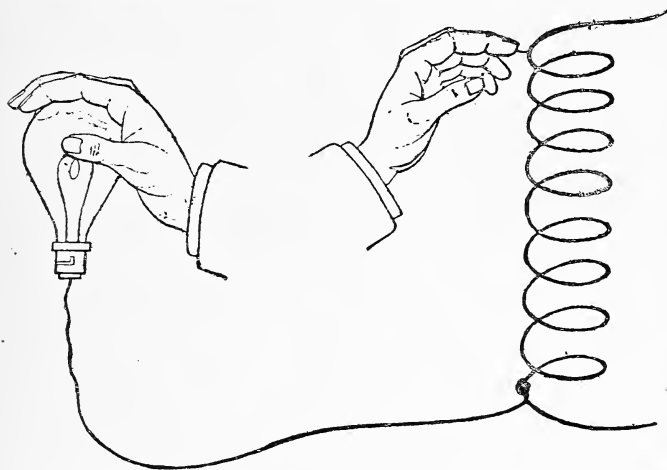

FIG. 48.—DIAGRAM OF TESLA'S EXPERIMENT.

on one pole it will glow with a red glow. If, however, the hand be brought to touch it, the glow will be considerably increased, owing to the fact that the capacity of the body has caused more of the currents to reach it.

Perhaps the most curious experiment de-

scribed by Tesla is that of a motor being made to turn by a single wire. This phenomenon is called by Tesla 'reluctancy of motors,' although he admits that he is not convinced of the reluctivity in the magnet of it; it is perhaps only an apparent phenomenon, due to parasitic currents on the fine windings.

The experiment can be repeated in the following manner: The primary of a coil is connected to one of the terminals of an H.F. apparatus, the secondary of the coil being situated outside a core of soft iron and short-circuited on itself. By such an arrangement a plate of metal capable of movement is brought within the magnetic field of the whole, when rotation will be manifest.

This peculiarity is termed by Tesla 'monopolar propagation,' and is very important, for beyond the explanation of the effects it produces, it opens up a range of applications which are utilizable in a variety of ways.

## RESONANCY.

A resonater is a piece of mechanism whose construction is such that it is capable of vibration, as in acoustics.

When two such bodies are vibrating in unison they are said to be syntonous. Most of us have seen the experiment of two tuning-forks tuned to the same pitch giving the same harmonic. If one be vibrated by a blow or by the fingers, the second fork will start vibrating by itself, and give off the same harmonic; because it is syntonous or vibrating in unison with the former, it will reinforce the sound given by the first vibrator. Similar phenomena can be produced with electrical apparatus and by electrical vibrations.

Helmholtz constructed some hollow metal globes of different dimensions; each one of these globes would respond to a note of the tonic sol-fa scale and reinforce the note which gave rise to it, thereby increasing the total amount of sound generated.

Hertz also constructed a resonator or vibrater giving very rapid oscillations. The apparatus was of low resistance, small capacity, and low self-induction; it consisted of an induced circuit formed by a length of copper wire bent so as nearly to form a circle, but having two balls at the extremities where they were brought near to one another.

This resonator was brought into the field of another vibrater, and as it was tuned in syntony with the vibrater, as soon as the resonator was put in action, Hertz's resonator would emit sparks from the two balls.

This is the principal and fundamental form of most resonators. Many others are used which are more complex, and with which it is possible to obtain effects of syntony or resonance.

The first of this form was suggested by Oudin in 1892, and first used by him in electro-therapy.

His resonator was constructed of a helix of wire of suitable length and diameter appropriate



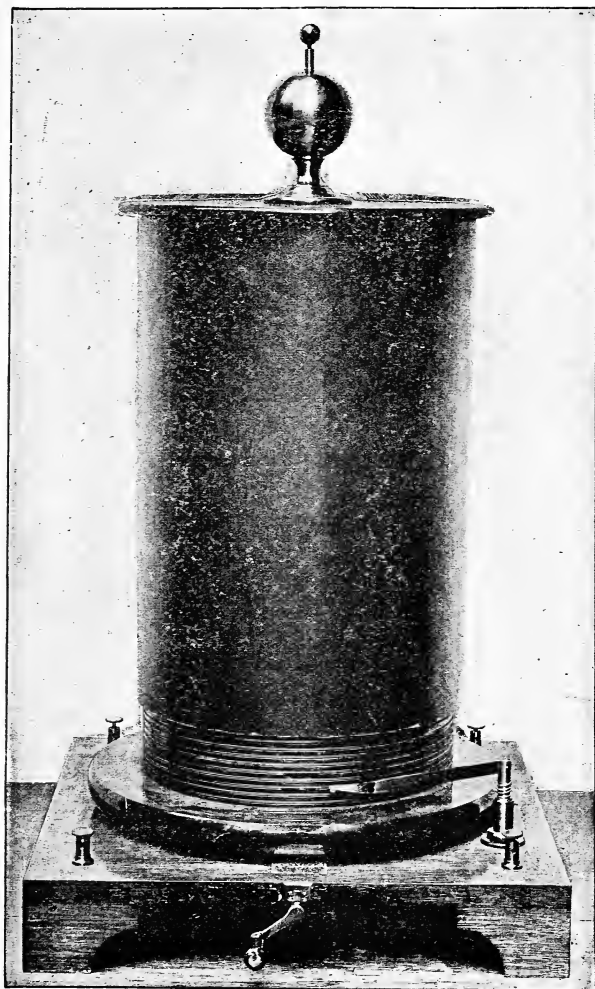

FIG. 49.—AUDIN'S RESONATER.

to the capacity of the inductor solenoid. When the solenoid was excited, an induced current appeared in the second solenoid or helix, which, by regulation, could be made to vibrate in unison with the inducing solenoid, and when the critical point was reached, a torrent of soft sparks would be seen emanating from the end of the induced solenoid or resonator, and the two would be vibrating like two vibrating tuning-forks. Should the harmony of action be disturbed in any way, the degree of sparking would be diminished or even destroyed.

Such sympathy would increase the tension of the current, as do two syntonous diapasons, and a resonator would create of itself an intense electric field which would affect a Geissler tube at a considerable distance or charge a piece of metal of sufficient capacity. I have even lit up a gas-jet at a considerable distance from the resonator by no other means than the finger-tip or a key held in the hand over the escaping gas.

One powerful form of resonator, constructed

---

by a London maker, will not only do this in the same room, but in the adjoining house. It is said to have played considerable havoc with the telephone in the immediate neighbourhood, so powerful is the electric field which this particular machine will create.



## CHAPTER V

### PHYSIOLOGICAL PROPERTIES

INSENSIBILITY OF MOTOR AND SENSORY NERVES—INHIBITION  
ACTION — STERILIZING ACTION ON PYOGENIC BACILLI ;  
ON TOXINS ; ON THE TUBERCLE BACILLI — ACTION ON  
GENERAL NUTRITION ; ON RESPIRATION ; ON THE BLOOD ;  
ON URINARY EXCRETION ; ON HEAT PRODUCTION



## CHAPTER V

### PHYSIOLOGICAL PROPERTIES

THE distinguishing characteristic of electrical currents of high frequency and high potential is that they cause no action on the motor or sensory nerves, so that the patient should not be conscious of the passing of these currents through the body (Fig. 50).

*Experiment.*—Place in the external circuit one or several persons, and interpose a few incandescent lamps of 125 volts 1 ampère. The filaments will light up without the persons feeling the slightest sensation. One can hardly—even with more intense currents, which, for example, reach 3 ampères, like those to which D'Arsonval submitted himself—feel but a slight sensation of heat at the point of entry and exit.

In relation to this, I will quote the observa-

tions of Lewis Jones, 'that the current through each lamp must have been 3 ampères, as estimated by D'Arsonval, is almost incredible,

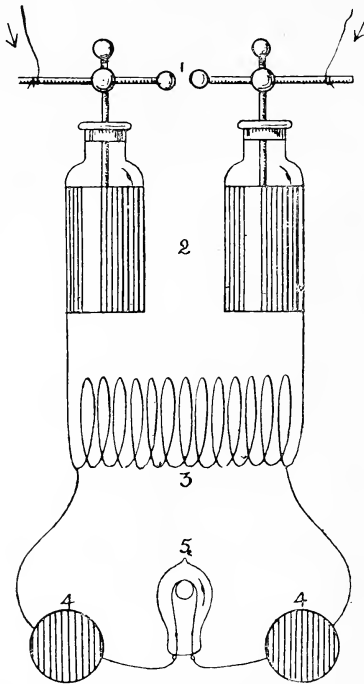

FIG. 50.—D'ARSONVAL'S EXPERIMENT.

for a current of such magnitude from any source of electrical currents, whether direct or alternating, would destroy life and produce serious burns of the tissues at the point of contact.'



One suggested explanation of the incandescence of the lamp filament is that at very high frequencies the resistance of the filament is enormously increased, and a smaller current at a proportionately higher voltage will make it glow.

Another explanation given is that the rushes of current are very considerable while they last, but they have so brief a duration that the total current passing in a given time is comparatively small; this, however, does not explain the difficulty of the absence of shock. Others, again, incline to the belief that the energy dissipated at the lamp filament is not so much an electrical current as a molecular disturbance or 'bombardment,' and that the actual current may be remarkably small. This theory is supported by the illumination of a lamp when fixed to one electrode only of a high-frequency coil. Here the true current must be quite small, and yet the lamp glows.

D'Arsonval states in regard to these experiments that currents of an intensity ten times less would be extremely dangerous if the

frequency, instead of being from 500,000 to 1,000,000 per second, was lowered to 100, as takes place in the alternating industrial currents. According to Tesla the innocuousness of these currents is accounted for by their not penetrating the body at the point of contact with the electrodes, but perpendicularly to the skin and equally over the entire surface of the body. At present the suggestion of D'Arsonval is the one generally accepted.

D'Arsonval admits that the motor and sensory nerves are so organized as to only respond to vibrations of a certain frequency, and has inquired into what becomes of the phenomena of neuro-muscular excitement when one indefinitely increases the number of electrical vibrations. He has shown that the waves, each of which produces a muscular shock if they are sufficiently distanced, no longer produce the same effect if their number increases in certain limits per second. Little by little the different contractions succeed in fusing together; the muscle then rests in permanent contraction—it is tetanized.

---

In order to arrive at this result, from twenty to thirty excitations per second are necessary if it concerns the muscles of a man. The muscle being tetanized, if the number of waves be further increased, the phenomena of neuro-muscular excitement increase equally till a maximum, which corresponds to 2,500 or 5,000 vibrations per second, is reached. From this moment the phenomena of excitation decrease as the number of vibrations increase per second. It is fair to assume, then, that when the number of excitations per second reach a height as that which distinguishes H.F., all neuro-muscular reaction is arrested. Therefore, owing to the extreme frequency of these currents, our nerves are incapable of responding to such rapid excitations. Let us consider the analogies of sight and hearing. The optic nerve can only perceive the vibrations of light about 500 billions (red) and 700 billions (violet) per second; to the infra-reds and the ultra-violets we are blind.

In the same manner our auditory nerves are impressionable to vibrations of a certain rapidity

only. Musical sounds corresponding to vibrations which are too slow or too rapid are not perceived.

Besides this tempting and generally adopted explanation of the innocuousness of high-frequency currents, D'Arsonval adds that one may still admit that these currents exercise on the nervous centres and on the muscles that peculiar and remarkable action termed 'inhibition.'

This inhibitory action of currents of high frequency is proved by several experiments :

1. Under the influence of these currents excitability to other stimulation is decreased. Local anæsthesia occurs at the point of penetration, which may last from one to twenty minutes.

2. In a dog the arterial tension falls some centimetres.

3. The sensibility of the skin to galvanism and faradization is greatly lessened after the passage of high frequency, although a greater strength of the former currents can be tolerated

than before electrification. Thus, in the application of the spark to warts, it is for less than a minute painful, but quickly becomes anæsthetic, and one may prolong the application even to the production of a sloughing process.

D'Arsonval and Charrin have published some experiments on the sterilizing action of these currents. By immersing a small solenoid of wire of two turns in a U-shaped tube containing broth and pyogenic bacilli, after half an hour's application the culture became discoloured and absolutely sterile. This has been thought by some English observers to have been due to the molecular shaking that the bacilli may have received.

M. Dimitriewski, of the University of Tomsk, has been working on various toxins by the effleuve method exclusively, and has found that the toxins lose their toxicity and become innocuous.

Quite recently Drs. Lagriffoul and Denoyès, of the Montpellier Faculty of Medicine, have published a very exhaustive series of experi-

ments on the action of 'high frequency' by auto-conduction on tuberculous guinea-pigs, and have proved that an actual inflammation is produced around the pulmonary foci; and that finally this abates and leaves the lung clear of the bacilli.

Other physiological effects have been published by Doumer, Oudin, Tripet, Guillaume, Bouniot, Bordier and Lecomte, Morton, Berlioz, and a host of others. A very brief résumé of their opinions is as follows: That H.F. currents in any form are able to produce modifications in the general nutrition of the patient; that there is an increase in the arterial tension; that respiration is increased, and a greater elimination of  $\text{CO}_2$  is evolved—usually from 17 to 37 litres per hour in a man; the blood becomes oxygenated; the abnormal ratio of urea and uric acid is reduced to normal; and there is an increase in the production of heat from 79 to 127 calories per hour, the temperature of the body remaining at normal.

## CHAPTER VI

### THERAPEUTIC METHODS

DIRECT APPLICATION: STABILE; LABILE — AUTO-CON-  
DUCTION—AUTO-CONDENSATION—MONOPOLAR—LOCAL  
APPLICATION, EFFLEUVE OR BRUSH ELECTRODES —  
MANAGEMENT AND USE OF RESONATORS: OUDIN'S,  
ETC.—ROCHEFORT'S BI-POLAR RESONATER, ETC.—  
D'ARSONVAL'S BI-POLAR RESONATER—ELECTRODES





## CHAPTER VI

### THERAPEUTIC METHODS

THERE are four chief methods of using high-frequency currents, each of which should be used in the production of particular results.

#### I. DIRECT APPLICATION OR BY DERIVATION.

1. If a patient be connected to the ends of the small solenoid by means of two large

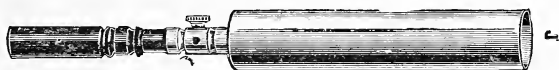

FIG. 51.—HANDLE METAL ELECTRODE.

handles (as above), the currents will pass through him by derivation, as, owing to the phenomenon of self-induction, the solenoid will offer a very great resistance (see Chap. IV.). This is easily proved by placing an incandescent lamp in the circuit, when it will glow.

To obtain the most perfect contact, the handles may be wrapped in wet flannel or wash-leather. If the connection between the skin of the patient and the metal be imperfect, small sparks will be observed to pass, and may be disagreeable to the patient.

In certain cases, where we wish to increase the area of penetration and to lessen the obstruction of the skin, the hand, arm, or foot bath may be used, by connecting some part of the patient to one end of the small solenoid and the other end to a metallic plate in the water of the bath, near to, but not in contact with, the skin.

Another way would be by using plates of tin or lead of various sizes in flannel or wash-leather bags, which should be wetted and applied—say, a large one over the sacral area connected with one end of the solenoid and one smaller plate to the sole of each foot, connected to the other end of the solenoid. If the area in contact with the skin be large enough, no sensation is felt, and nothing abnormal happens.

If the contact be imperfect, little ulcers may be produced, either by unevenness of the metal or its covering. With the most powerful installations, when the handles are used after prolonged electrification, and of 500 or more milliampères, slight heat and tingling may be felt

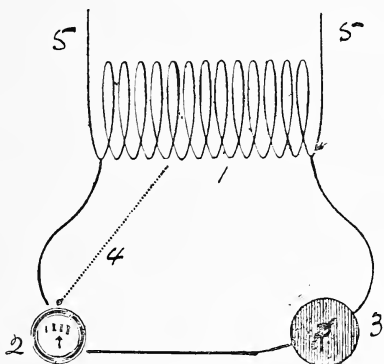

FIG. 52.—DIRECT APPLICATION.

1, Solenoid ; 2, Milliampèremeter ; 3, patient ; 4, movable contact, to vary intensity ; from Leyden Jars.

in the hands and up the arms. This is not apparent on a properly-constructed couch.

The above methods are termed 'stable,' from the patient being connected to both ends of the small solenoid. This may also be termed the bi-polar method.

2. Another modification is termed 'labile,' and in this the patient is connected to the solenoid by a fixed electrode, whilst the other end is at the disposal of the practitioner (Fig. 51, 4), who, with a thoroughly insulated handle, is able to direct its electrode end to any part of the patient. This modification produces very different results from the stabile form. By approaching the skin with the insulated electrode, sparks appear, and the actual contact, even for a few seconds, produces an erythematous blush of considerable area, the reaction being somewhat intense to the patient's sensations.

*Duration of each Séance.*—This can only be judged by the practitioner after some practical treatment, but my experience has led me to believe that they should be of short duration. In general diseases, one would start with a few minutes' direct auto-condensation or auto-conduction, in daily doses, carefully noting any subjective symptoms. If somewhat overdosed the patient may feel a certain degree of lassi-

tude, lasting more or less for several hours, or, on the other hand, may feel brighter and invigorated. In tuberculous cases the temperature chart is the very best indication for increasing or reducing the period of application. It must not be forgotten that the actual strength of dose can be varied. A D'Arsonval milliampère metre should always be used, the range of which should extend to 700 milliampères.

With local treatment we have ocular evidence to guide us, that a reaction is produced at the time and continues for a few hours or so after. Let us take as an example a small patch of lupus vulgaris of about 2 square inches. We will use a glass electrode of low vacuum, connected to the free end of the resonator, and, placing it in actual contact with the patient and by a judicious choice of the number of spirals used, we 'cut down' the discharge to almost nil. After five minutes' application we see that the patch looks more inflamed, and to the touch we can feel its heat ;

the patient also tells us that it feels warm. For a few hours or so that warmth will increase, and be at its maximum in about six hours, gradually passing off by the next morning. On examination twenty-four hours afterwards we notice the patch looking more inflamed, and it may feel slightly warmer than on the previous day. If we do not think the reaction has been sufficient, we may increase both the duration of application and also the strength of the current. Speaking generally, after a few applications the patch dries up, scaling takes place, but the redness or brown staining may persist for some considerable time after cessation of the treatment. One must always bear in mind that local treatment, whether by effleuve or otherwise, will, if persisted in for any length of time, cause inflammation on healed or healthy parts. The treatment may be applied once or twice daily for two weeks; then once daily or every other day for a similar period, and so on, reducing the number of applications week by

week. The dosage requires just as much discretion as that of any other therapeutic measure. According to Sudnik, in neuralgias and the like, more rapid improvement sometimes is attained by intensities of 100 milliampères than by a higher intensity. We have often confirmed this peculiar phenomenon.

Another point worth noting is that one will frequently find that if the patient has any kind of pain at the commencement of the sittings it may, by somewhat energetic treatment, be increased. I have noticed this more especially in cases of sciatica, compelling one to curtail the dose, but certainly, when the patient can tolerate a slight increase of pain, the duration of the application should be shortened ; all depends upon the nature of the disease and the degree of tolerance of the individual.

Defective contacts between the patient and the apparatus, or in the apparatus itself, may mean unpleasant sensations or even shocks to him.

## 2. AUTO-CONDUCTION BY THE SOLENOID.

The noteworthy feature of this method is that the patient is not in actual metallic contact with the solenoid. The solenoid is made like

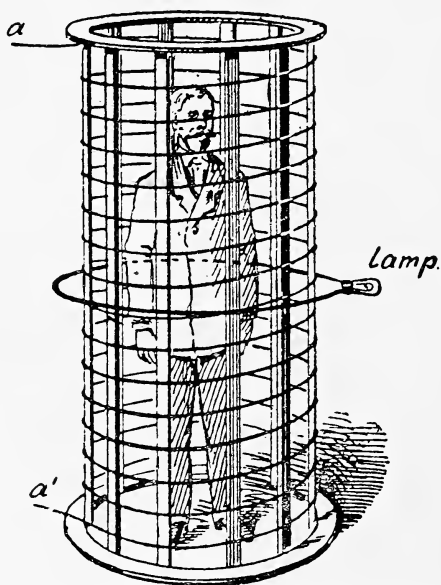

FIG. 53.—UPRIGHT AUTO-CONDUCTION CAGE.

a cage, and large enough to envelope the patient, who either stands up inside it or lies on a couch, as shown in Fig. 39. Smaller cages may be used for arm, leg, etc.



The passage of the current through the cage induces by mutual induction high-frequency currents in the tissues of the patient, which

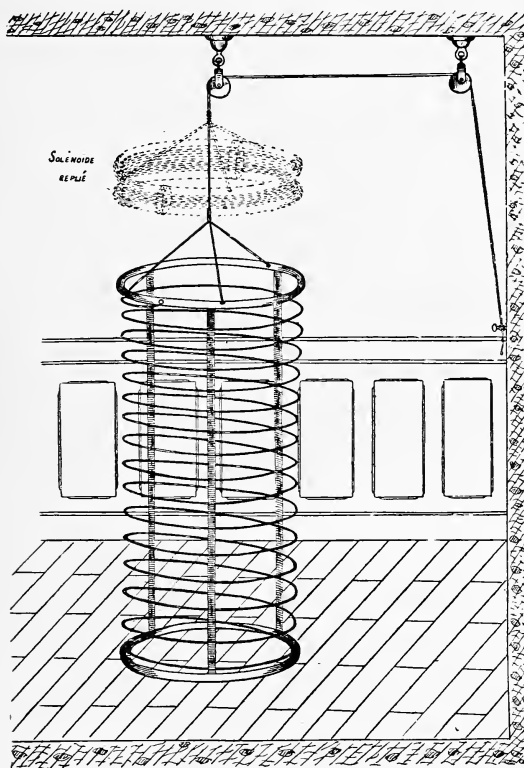

FIG. 54.—COLLAPSIBLE AUTO-CONDUCTION CAGE.

Dotted lines show cage drawn up when not in use.

may be demonstrated by sparks being drawn from any part of him—that is to say, he is

saturated by being placed in the field of the currents.

If a lamp of 20 volts be used to close the circuit of a single coil of thick wire, it illuminates with a brilliant light at a distance of more than 3 feet, as in Fig. 53. Any conducting body plunged into this field becomes influenced with induced currents.

If a single copper wire of one turn is introduced, the induction produced in this wire will be sufficient to light up two lamps of 110 volts mounted in series. Place the patient in the large solenoid, and let him unite his arms in such a way as to form a circuit which is completed by an incandescent lamp, the terminals of which communicate with each hand. The lamp is lighted with this induced current in the circuit thus formed. Another more certain method is to plunge each hand into a vessel containing a slightly alkaline solution of hydrochlorate of ammonia. Under these conditions the absorption by the skin makes the resistance fall to the extent of

600 ohms. As it is known that the electromotive force induced from a single coil can easily attain 100 volts, one can say that the intensity of the current which emanates from the arms may approximately reach  $\frac{100}{600} = 160$  milliamperes.

Apostoli and Berlioz have described another modification, the patient being placed as above, and connected by the hands with one pole of the solenoid. Under these conditions the patient is treated by direct and auto-conduction, the effects of both being thereby increased.

The effects seem to be much like auto-condensation, which is chiefly used in treating general conditions, such as rheumatism, anæmia, chlorosis, and certain forms of diabetes. One sometimes gets better effects from changing from one form of treatment to another.

As yet no hard-and-fast rule can be adopted; everything must be left to the discretion and experience of the medical man.

### 3. AUTO-CONDENSATION.

This is achieved by making the patient constitute one armature of a condenser, whilst the other consists of a large sheet of metal in the vicinity of him. This is most conveniently effected by means of a couch, the patient lying on cushions filled with insulating material (rubber waste), which separates him from the metal sheet below, whilst he holds in his hands metal electrodes connected with the other end of the solenoid.

These handles should be large and firmly gripped, for, as Dr. Hedley has shown, 'if the electrodes in contact with the skin be progressively diminished in area, a point is reached with very small handles when a distinct sensation becomes perceptible.'

Sparks may be drawn from any part of the patient, and one should remember that they are somewhat sharp if taken through the clothing. An ordinary Geissler tube may be illuminated in actual contact with and for a foot or so from the

patient. Sometimes one experiences a trembling or a 'pins and needles' sensation immediately on turning on the current, more especially if the handles are gripped hard; it, however, generally quickly passes off, and is at no time disagreeable.

In my experience auto-condensation un-

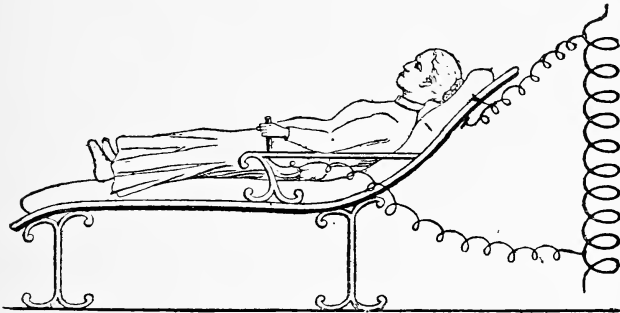

FIG. 55.—DIAGRAM OF AUTO-CONDENSATION.

doubtedly produces greater effects in the majority of patients than auto-conduction.

A bed or ordinary armchair properly prepared may be improvised for the purpose of condensation, lining the chair with a metal sheet and placing the patient on insulated cushions. With efficient means we can pass 400 to 500

milliampères through the body. The patient is charged and discharged at each oscillation of the condensers.

The patient may be in connection with only one of the ends of the solenoid. Such would be termed the uni- or mono-polar method.

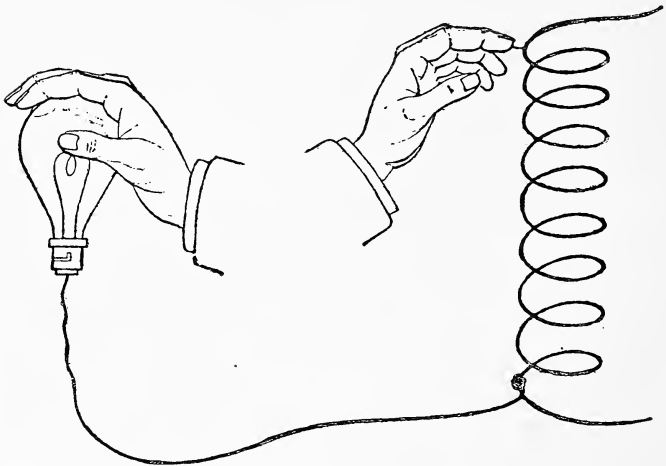

FIG. 56.—DIAGRAM OF EXPERIMENT OF CONDENSATION.

The following experiment will demonstrate the application by condensation: An incandescent lamp is connected to the solenoid by a single wire. If taken in the hand, it will light up brightly whilst holding it if the other hand is put near the opposite end of the coil, as in

Fig. 56; in this case it is the filament which plays the part of one armature, the glass that

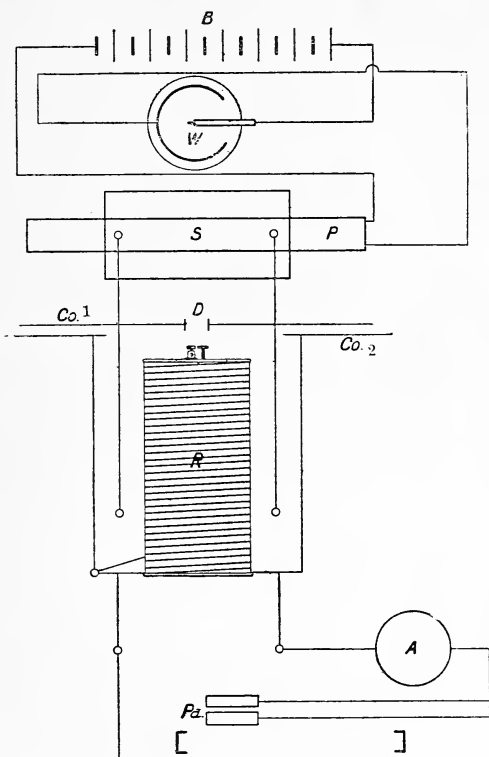

FIG. 57.—SCHEMA OF AUTO-CONDENSATION, WITH ELECTROLYTIC INTERRUPTER.

*B*, Accumulators; *W*, Wehnelt interrupter; *P*, Primary of induction coil; *S*, secondary; *Co.1*, inner armatures Leyden jars; *D*, spark-gap; *Co.2*, outer armatures connected to *R*, resonator; *A*, milliamperemeter to *Pa*, patient [Insulated Couch] on sheet of metal.

of the dielectric, and the damp skin constitutes the other armature.

#### 4. LOCAL APPLICATIONS.

These are applied by means of connecting the solenoid to the beginning of a large number of helically arranged copper spirals, by which we can obtain from the other end a brush discharge or 'effleuve' of very high E.M.F., varying in length from  $\frac{1}{2}$  inch to 12 inches, which can be applied locally by means of metal electrodes (Figs. 58, 59), and which feels at a non-sparking distance to the sensations as a soft, warm breeze. An alternative method is to attach the other end of the solenoid to the patient's skin by means of a large metal plate or by earthing, by which we can increase the length of the effleuve. With care it can be applied to inflamed and sensitive surfaces, preferably by means of a glass electrode of low resistance. On healthy skin, to produce redness it is necessary to spark it, the time required being in relation to the intensity of the spark discharge. On unhealthy or ulcerated patches it is usually unnecessary to spark, the soft





FIG. 58.—LARGE REGULATING EFFLEUVE.



FIG. 59.—MEDIUM-SIZED EFFLEUVE.

effleuve being sufficient to produce reaction ;  
this generally gets worse for a few hours after

the application. With a metal electrode, kept at such a distance as to produce a painful white spark, an actual blister may be caused.

It is possible to obtain discharges for local application direct from the solenoid, but, generally, they are found to be of too painful a nature, and are rarely employed. These drawbacks can be avoided by raising the tension of the high-pressure current in two different ways: (1) By utilizing the induced current in a coil of fine wire fixed to the solenoid and submerged in oil or suitably insulated; or (2) utilizing the properties of resonance. The latter method is the one most generally used.

In 1892 Oudin was the first who adopted the method of increasing the tension by resonance, interposing a resonator between the patient and the solenoid.

His resonator consisted of a long solenoid of 40 to 50 yards of bare copper wire wound round a vertical wooden cylinder about 8 inches in diameter and from 15 to 18 inches in height. A flexible wire was connected with one end of

the solenoid, and came in contact with the coils of the resonator by a hook or clip. This was to allow of regulation. The other end of the solenoid was free and 'earthed.' Later he found that the product of the machine was increased by conducting the free end of the solenoid to the lower coil of the resonator. He removed the solenoid and replaced it by the lower coil of the resonator.

This type is figured on p. 68, where we dealt with its construction.

The following are a few practical hints as to its management, and will probably be found useful.

As will be seen, the spark-gap is usually enclosed in a china, glass, vulcanite, or other receptacle to reduce the sound of the spark, which in most instances is very considerable. This should be frequently wiped out, as a moisture, and in some cases a compound of nitrous acid, is formed on the inside, thereby diverting the discharge, causing it to leap round the sides. If the knobs or discs at the gap are too close, the spark discharge

may 'arc,' and either crack the glass or porcelain, or, if made of vulcanite, may set it alight. Prior to turning on the current, the gap should be practically closed, then adjusted to the requisite distance, when the sparks, which should be numerous, will be white in colour and with clear-cut edges.

By gently withdrawing one of the terminals, the maximum effluve can be seen at the free end of the resonator, which can be then sprayed on the patient by means of one of the numerous electrodes figured.

We can regulate the discharge from any resonator by either modifying the initial current which feeds the jars or by adjustment of the spark-gap (detonator).

In the models of some Continental makers, it is the wooden cylinder which turns before the roller, which goes up and down, following one of its contacts (see Fig. 50).

Another effective model, constructed by Isenthal and Co., consists of a resonator and solenoid placed apart, as seen in Fig. 60.

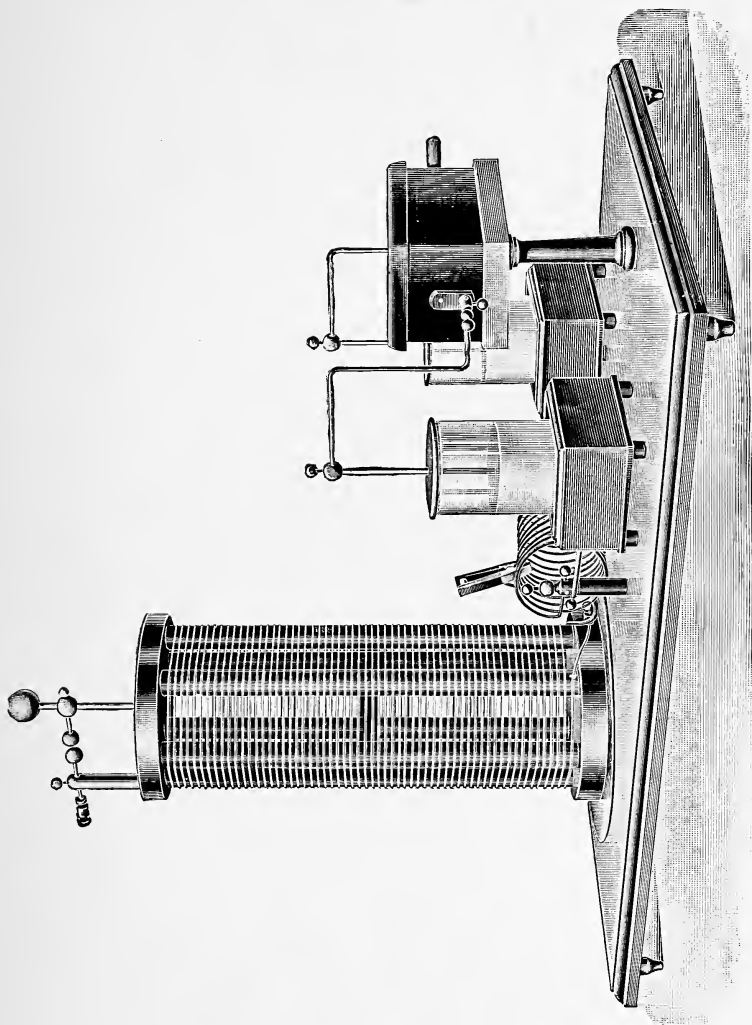

FIG. 60.—ISENTHAL-LOUDIN RESONATER.

It is in the smaller or lower solenoid, which is interposed between the external armatures of the Leyden jars, that the oscillations of high potential originate; in the second upright and much longer coil the potential is highly raised. This machine is a conveniently - constructed model.

On this principle manufacturers have constructed different forms of resonaters.

Fig. 61 represents Gaiffe's form. In reality a variety of Oudin, and extensively elaborated, it constitutes an inducto-resonater. In consequence of the position of the two solenoids, the primary surrounding the secondary or solenoid of resonance, a phenomenon of induction is added to that of resonance. This machine has the advantage of being easy to use according to the nature of the case—either in a general way, effleuve, or sparks. M. Rochefort has introduced a bi-polar resonater, which consists of two resonaters, between which, when properly regulated, flows a current of extreme power. A contrary sign at the same moment

emanates from the symmetrical points of the two machines. In this new arrangement (Fig. 35) four Leyden jars, divided into two batteries, are connected, two and two, with one of the knobs and by conductors to their interior armature.

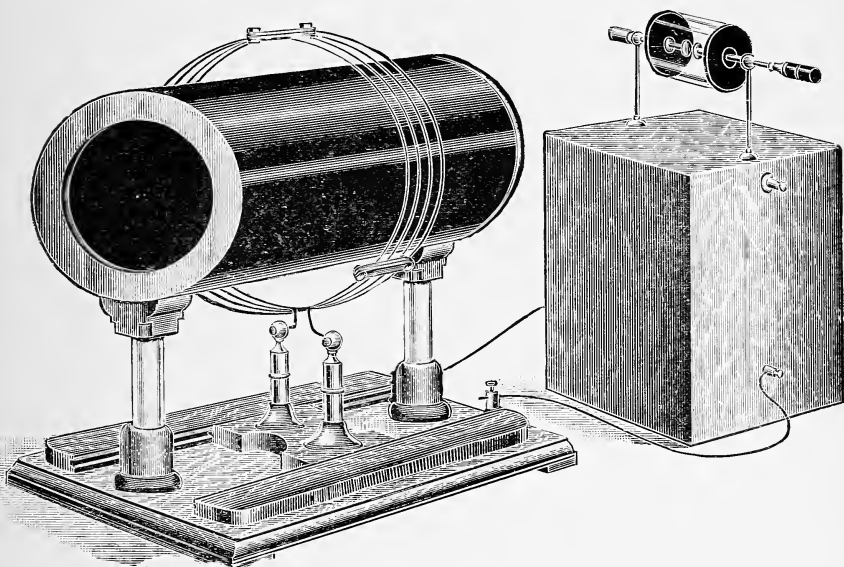

FIG. 61.—GAIFFE'S FORM OF BI-POLAR RESONATER,  
WITH CONDENSER.

The four exterior armatures are united to the two resonaters in such a way that the two armatures of the same battery should be, one on the coil of the lowest, the other on the coil

of the highest, which is called the primary, of each of the resonaters.

Under these conditions, although the two resonaters have an influence one on the other, they are separated electrically, and act as two resonaters governed by the same interrupter, and each receiving an equal current, but joined in the contrary direction in each primary of the resonater.

With this double resonater, and by placing the patient's chest between the two effleuves, the largest amount of brush discharge is obtained.

It may be used locally by means of an electrode attached to one resonater, and may give an effleuve 12 or more inches in length; but it must be remembered that with 12 inches of effleuve we can only use about  $1\frac{1}{2}$  inches, as nearer than 10 inches to the electrode we get a spark discharge of a painful nature.

Another method is a combination of auto-condensation with effleuve, by placing the patient on the couch connected to the top of one resonater, and then using the metallic brush



from the other. Here, again, sparking must be avoided by keeping the brush at a safe distance.

Finally, D'Arsonval has constructed a bi-

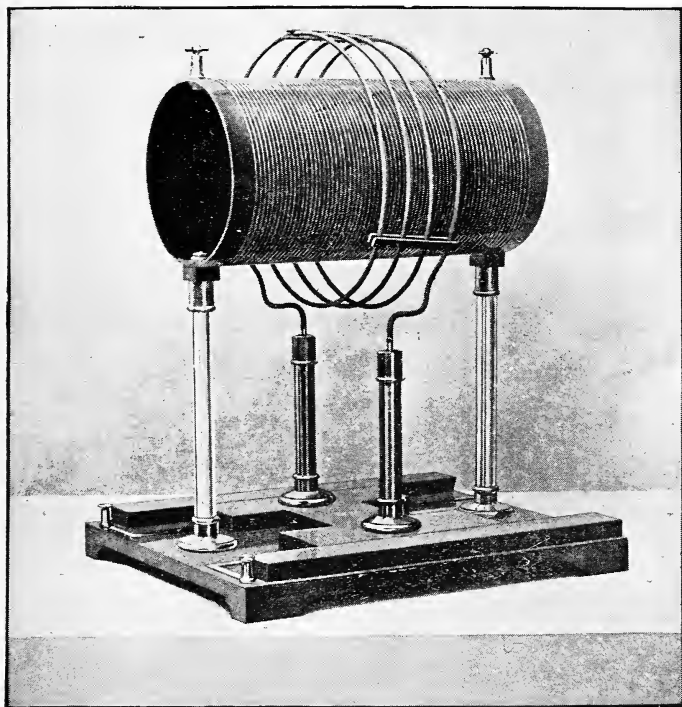

FIG. 62.—D'ARSONVAL'S BI-POLAR RESONATER.

polar coil of high potential. This machine, which allows of a very good gradation of effects, is made up of an insulated wire, which

makes, as one can see in the figure, a large number of turns. All round and at a certain

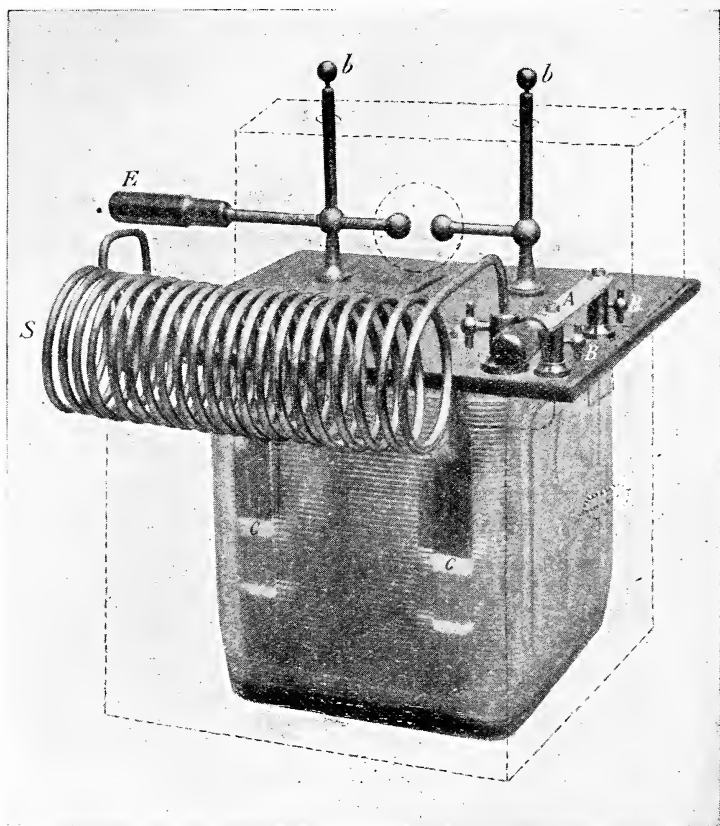

FIG. 63.—GAIFFE'S CONDENSER AND SOLENOID FOR AUTO-CONDENSATION.

distance are fixed four induction coils of thick wire carried by an insulated support which can

be run along parallel to the induction bobbin, and has the great advantage that the induced and inductor always agree. One can practise with this machine the single or double effleuve according to whether one or two poles are used. The current of high frequency is carried to the two terminals of the induction coil. The contact with the current applicable to the patient is brought, according to circumstances, to the two ends of the induced coil or to a single one, the other being earthed.

#### ELECTRODES.

We have already mentioned the chief forms of electrodes; there are, however, numerous others which merit notice.

Early in 1902 Mr. Hall-Edwards exhibited at a meeting of the British Electro-Therapeutic Society some electrodes specially designed for the treatment of gonorrhœa in the male and female, and leucorrhœa in the female. They were made of metal, nickel-plated, 6 × 7 inches. The female electrode is made of such a size that

the vagina is completely dilated by it. Should the instrument not be sufficiently large, folds in the vaginal wall will prevent the full therapeutic effects being secured. Another was specially designed for treatment of the prostatic portion of the urethra, and for slight cases only involving the anterior portion. The drawback to the use of these instruments is the fact that the greater portion of the energy is expended at the mouth of the urethra or vagina, as the case may be, instead of being distributed equally along its whole length. This drawback was so marked that he has given up their use in favour of similar shaped instruments made of solid vulcanite, with a wire running down the centre. These have the additional advantage that actual sparking takes place along their whole length, a condition of things highly desirable.

For cancer of the uterus and rectum he has also devised electrodes with the ends made of glass, and exhausted nearly to the condition necessary for the production of X rays. These instru-

ments are capable of further improvement, but even in their crude state are highly efficient. Both these electrodes have the advantage of giving off ultra-violet light in addition.

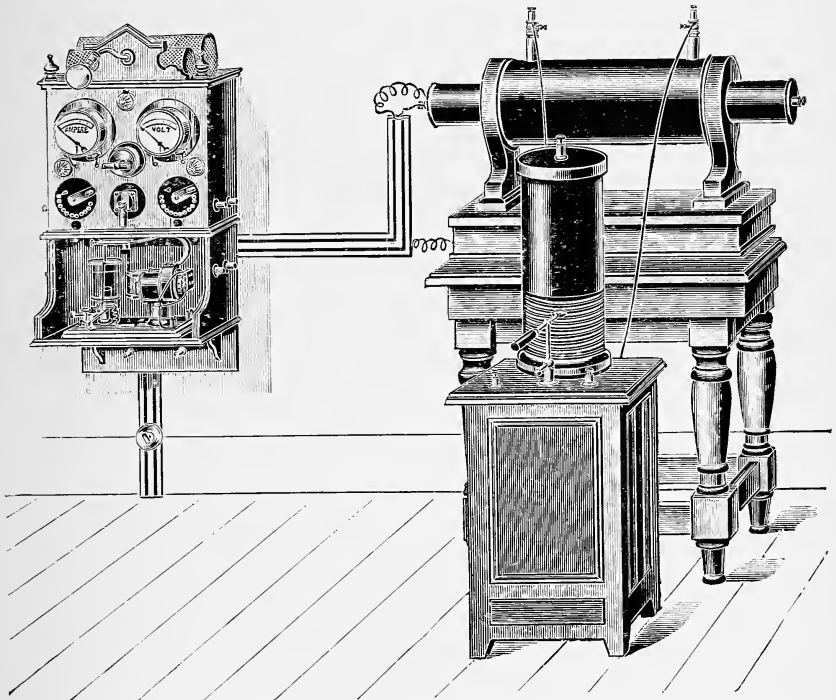

FIG. 64.—A RECENT GROUP OF HIGH-FREQUENCY APPARATUS WITH SILENCED SPARK-GAP, SUITABLE FOR ALL FORMS OF TREATMENT.

Quite recently Dr. George Herschell has devised a method of concentrating the high-

frequency current upon the mucosa of the stomach and intestines.\* He effects this by applying a metallic electrode to the surface of the tongue and another within the anus. He finds that, as might be expected, at least double the amount of electricity will pass as can be caused to do percutaneously; with an ordinary high-frequency apparatus about 700 to

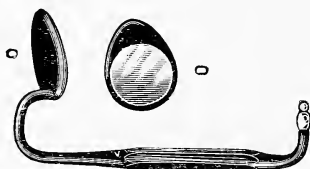

FIG. 65.—HERSCHELL'S TONGUE ELECTRODE.

800 milliamperes can be given, and this without any sensation to the patient. According to well-known laws the electricity will pass along the line of least resistance, and will thus pass mainly in the substance of or along the surface of the mucous membrane of the alimentary tract. An electrode used for application to the tongue consists of a Stoerq's

\* Herschell, 'Manual of Intra-gastric Technique,' London, 1903.

tongue depressor, to the lower surface of which is attached a metal plate connected by a wire passing through the handle to a binding screw.



FIG. 66.—HERSCHELL'S REGULATING HANDLE AND RECTAL ELECTRODE.

The rectal electrode consists of a metal bulb carried upon a regulating handle, as Fig. 66.

Dr. Herschell finds that much greater effect

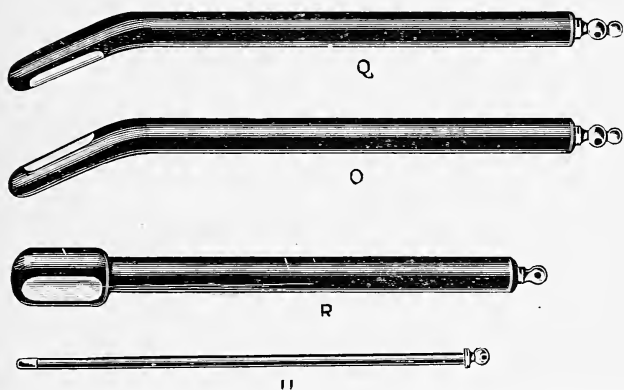

FIG. 67.—PROSTATE, PERINEAL AND URETHRAL ELECTRODES.

can be produced by this method of application than by external electrodes, and he has especially obtained good results in the treat-

ment of gastric ulcer, chronic gastritis, and chronic catarrh of the intestines.

Fig. 67 is a set of four electrodes suggested by Mr. Hurry Fenwick, and consists of a

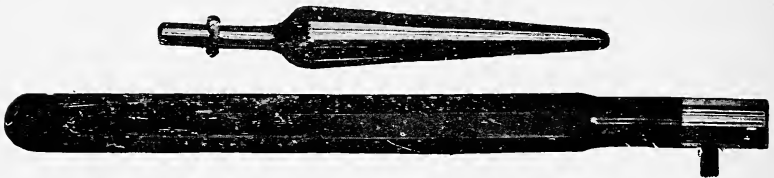

FIG. 68.—DR. DOUMER'S RECTAL EXCITATEUR, AND HANDLE FOR SAME.

urethral, perineal and two beaked rectal electrodes for treatment of the prostatic portion of the bladder.

Another electrode of very general use in

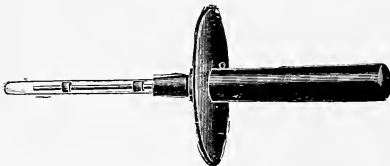

FIG. 69.—GLASS CONDENSER ELECTRODE.

France was introduced by Dr. Doumer, and is for the treatment of hæmorrhoids, and is mounted on an insulated handle, as seen in Fig. 68.



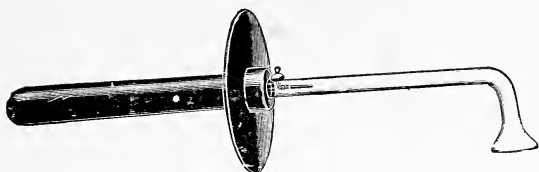

FIG. 70.—VACUUM ELECTRODE FOR EXTERNAL USE.

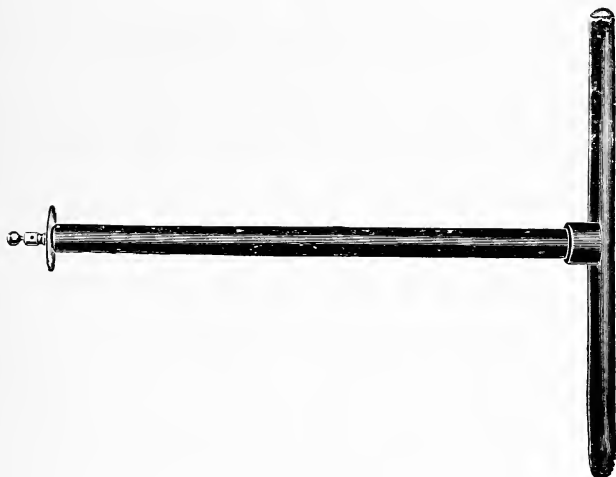

FIG. 71.—EBONITE SPINAL ELECTRODE.

Isenthal and Co. have introduced some vacuum electrodes in coloured glass, as Figs. 69 and 70, and in vulcanite, as Fig. 71.

## DESCRIPTION OF HIGH-FREQUENCY GROUP

THE group shown in the illustration is a complete set of machines for the production and administration of high-frequency currents. As will be seen, the group comprises a switchboard with a motor interrupter of the dipper type, which is installed in the recess in the lower half of the board. The current, which may be derived from accumulators or the electric light mains, is brought to the lower portion of the switchboard. The current is then distributed to the switches, motor, resistances, ammeter and voltmeter, above interrupter, and from terminals on the right side of the board to a large coil which is seen beside it. The coil is of the multisectional type, and gives a heavy discharge, the nominal discharge being 12 inches. From the coil the secondary current passes into the high-frequency machine which stands in front of the coil. This type of high-frequency machine is a modified Oudin resonator. On the table of this apparatus are placed two terminals, to which are connected two conducting-cords; one of the conducting-cords is attached to the foot of the couch shown, whilst the other is led to one side of a milliampèremeter attached to the wall, and from the other side to the head of the couch, and thence to the handles. A small solenoid for local applications by auto-conduction is seen in the illustration. As will be seen, a table is at hand, on which the various electrodes are placed. The group is easy of manipulation and perfectly safe, and generally a very effective combination.

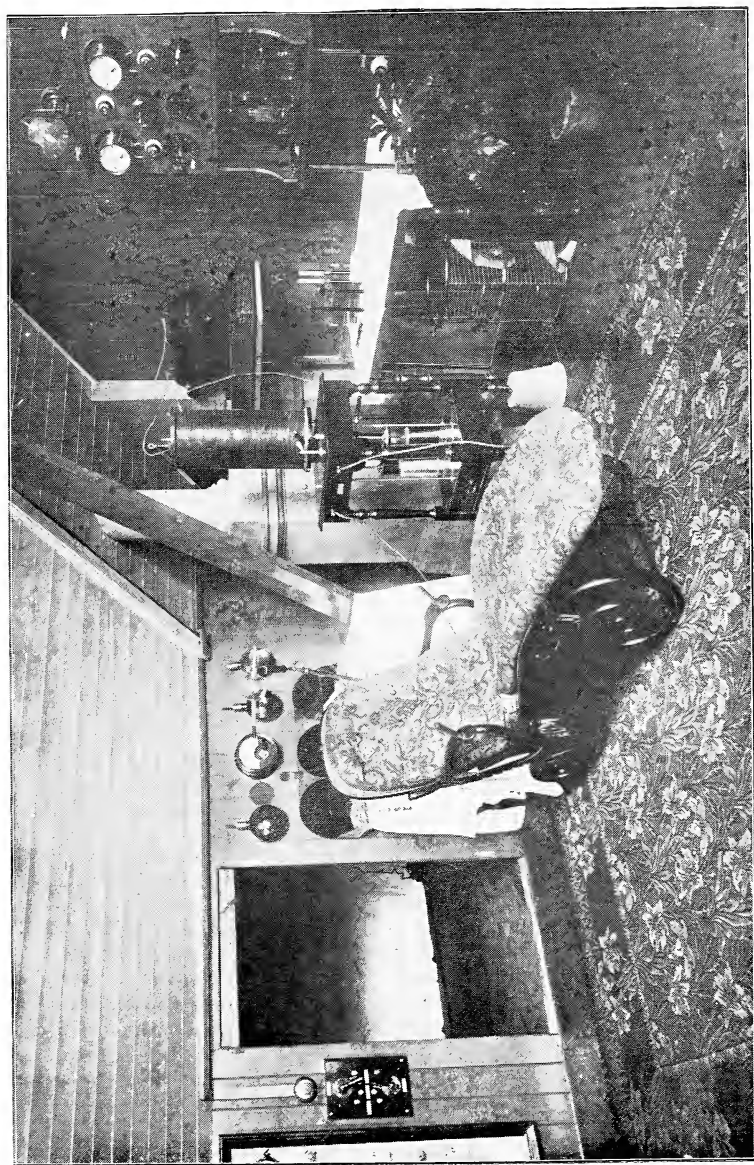

FIG. 72.—A COMPLETE INSTALLATION FOR HIGH-FREQUENCY TREATMENT.



## CHAPTER VII

### SOME GENERAL DISEASES

DIABETES—GOUT—RHEUMATISM (CHRONIC)—  
OBESITY—HYSTERIA—ANÆMIA AND CHLOROSIS  
—NEURASTHENIA—PULMONARY TUBERCULOSIS  
—DYSPEPSIA—ATONIC DILATATION OF STOMACH  
—COLITIS



## CHAPTER VII

### SOME GENERAL DISEASES

#### DIABETES.

HIGH-FREQUENCY currents have been much extolled for this disease. Personally, only a few cases have been under my care, but the results have been most satisfactory in each one; the sugar and accompanying symptoms disappeared in an average of six weeks' treatment. One case has had two relapses in eighteen months, but each time the sugar has been more readily eliminated, and the intervals between a reappearance of the symptoms have been of longer duration. The first recorded cases were from D'Arsonval and Charrin.

A male, aged thirty-three, under my care, had been affected some years, and was put under observation for a fortnight without treat-

ment. Under these conditions he passed on an average 16 pints of urine in the twenty-four hours, having a specific gravity of 1,036, and containing 32·3 grains of sugar per ounce. His arterial pressure equalled 15 centimetres of mercury, pulse 72, temperature subnormal. Ten minutes' treatment daily.

During the first week not much modification of the urine was noticed, except that the quantity fell from 16 to 11 pints per twenty-four hours. After the second week improvement was more marked, 7 pints only being passed; the sugar fell to 14·1 grains per ounce; arterial pressure rose to 25; pulse 104; temperature normal. After one month 3 grains of sugar were being passed, and his weight had increased 6 pounds. The patient, with no further treatment, made an excellent recovery.

Reale and De Renzi have also published many favourable observations on the good effects produced by H.F. currents in diabetes.

G. S. Vians (Turin), Vinaj, and Vietta have



treated diabetes chiefly by auto-conduction, with total disappearance of the sugar.

Boedeker, on the other hand, has in three cases noticed no amelioration in the quantity of sugar passed, but that the general condition was much improved. From the published results of numerous other authors, it is exceedingly difficult to exactly determine the therapeutic value of H.F. currents, the general consensus of opinion, however, among those who have worked in this direction being distinctly favourable to their use.

### GOUT.

In the treatment of gout, H.F. currents have been used alone, and also in conjunction with other forms of electricity. When used alone, auto-condensation and conduction have been chiefly employed. One is able from a fair experience to formulate a few rules in the number and duration of sittings. They had better not be applied during an acute painful attack. Low intensity and short duration of

sittings at first should be used, and they should be progressively increased. If an acute attack supervenes, stop for a time. The treatment should be persisted in for several months, with short intervals, in old-standing cases.

I have been unable to find any reports of failure in this condition, but, on the other hand, the authors who have had experience with H.F. treatment are far too numerous to quote in this small book.

#### CHRONIC RHEUMATISM.

The following case is a fair example of the use of H.F. treatment in rheumatism. The patient was sent to me with the following diagnoses by three separate physicians: gout, gouty rheumatism, and rheumatism.

B. B., aged forty-eight; much gout and rheumatism on both sides of his family. Patient had typhoid at eighteen years; dyspepsia with attacks of acute gastritis ever since. Rheumatic fever at twenty-six years. Complained of dyspepsia, with rheumatic pains.

all over, but especially in lumbar region, and a history of several big-toe-joint attacks. Small joints all more or less enlarged. Appetite nil, and sleep bad.

He was treated to ten minutes' daily application by means of auto-condensation. Milli-ampèremeter registered 350. Week by week his urine was examined by the Clinical Research Association, and showed at first a gradual increase in the ratio of uric acid to urea, as the following figures will show: Before treatment it was 1 to 51.5; end of first week, 1 to 63.5; second, 1 to 70.3; third, 1 to 64.8; fourth, 1 to 46.7; fifth, 1 to 41; sixth, 1 to 34.5; Hopkins' normal being 1 to 35. At the end of the seventh week, the urine being normal, treatment was stopped, as all pain had ceased; the appetite had increased, and the patient regained his natural sleep. His weight increased  $6\frac{1}{4}$  pounds in the seven weeks' treatment.

In chronic rheumatism the greatest benefit is derived from high-frequency currents.

## OBESITY.

Many remarkable results have been recorded, chiefly by Continental practitioners, on the value of these currents in cases of obesity. Foneau de Courmelles was the first to make observations on this subject in the year 1877. Boinet and Caillol de Poucy have published several cases where the decrease averaged 14 pounds per month. The above cases were all treated by auto-conduction. I have frequently noticed a loss whilst treating patients for other conditions; probably the general increase of the digestive functions is mainly responsible for the improvement.

In one patient the girth was reduced 4 inches in nine weeks, with no marked diminution of the patient's weight, but with marked personal comfort. As a rule, phosphates and urates are excreted in large quantities.

## HYSTERIA.

From the very few cases that one has personally been able to test, it seems to be

ameliorated in about the same average time as under the Weir-Mitchell treatment. The patient's general condition, weight, etc., seem to improve in spite of herself. The treatment was conducted in such a way that she in each case knew absolutely nothing of the currents to which she was being subjected. All she was cognizant of was of having to lie on a couch holding two handles and hearing a distant buzzing sound. A light nutritious diet was ordered, but with no special regulations. A good sign was when the patient became persistent in her inquiries as to what form of treatment she was undergoing.

#### ANÆMIA AND CHLOROSIS

The currents, when applied generally by auto-condensation or conduction, seem to quickly increase the hæmoglobin of the red corpuscles. Frequently I have found the cells increase in a most satisfactory manner, and quickly regain their healthy tint. This one would expect from the physiological phenomena already referred to in a previous chapter.

## NEURASTHENIA.

In all, twenty-three cases have been treated. Their ages varied from twenty-six to sixty-one years. They all derived much benefit from auto-condensation, 5 to 10 minute sittings, 350 milliampères. Eighteen were absolute cures. Six had two courses (course, twenty-four sittings). Eight were about the 'climacteric.'

## PULMONARY TUBERCULOSIS.

In July, 1901, the author read a paper on 'The Treatment of Phthisis by Electrical Currents of High Frequency and High Potential,' before the British Medical Association at Cheltenham, and observed that forty-three consecutive cases were treated. There is reason to believe that the currents act in these cases in the following manner :

Firstly, on the tubercle bacilli themselves by making them pursue the same course as if they were under the X rays. According to the experiments of Drs. Forbes Ross and Norris

Wolfenden, in their paper on the 'Effects produced in Cultures of Tubercle Bacilli by Exposure to the Influence of an X-ray Tube' (*Archives of the Roentgen Ray*, August, 1900), they observe that the bacilli rapidly increase in numbers and have a tendency to form clumps, then get small in numbers and shape, and take the microscopical stains very readily, but are pale in colour. They say, in conclusion, 'There is not the smallest doubt that X rays stimulate them to excessive overgrowth, and only affect them adversely by attenuation from overgrowth.'

In my experience much the same process goes on under the high-frequency treatment. The tubercle bacilli, which are usually present in fair numbers, quickly begin to increase, and after a few applications are greatly increased; they soon, however, form clumps and get misshapen, short, and stumpy, and generally curved, and take the stain far more readily than before. After a time they begin to decrease in numbers, and later, when the patient

is obviously getting better in every respect, they may cease entirely, and may appear in the sputum after weeks of absence.

Secondly, the effects of the currents of high frequency on the individual cells of the body. We judge this by the appetite and digestive powers increasing, and the patient's gain in weight. The general improvement of the body-cells probably makes them more resistant to the inroads of the tubercle bacilli; but whether the lowering of the tubercle's vitality, or a raising of the body-cells' resisting power, or a combination of both is at work, for our purpose matters little. In the majority of these cases the leucocytes were greatly increased in numbers during a course of the treatment.

In some cases the temperature is the first thing affected. Presuming that the daily variation had been of about  $3^{\circ}$  between the evening rise and the morning fall, either after the first application or, at most, after the third (consecutive days), the evening rise should be



higher and the morning fall less. On examining the affected area, we find the physical signs at first increased; thus more coarse râles of louder and of a greater number could be found; the expectoration becomes larger in amount, and the cough more frequent and easier. After a few applications, generally when given locally, the patient often complains of pain or an uncomfortable feeling over the affected part. This, as a rule, passes off after a couple of weeks' treatment, and is never severe if we pay due attention to the length of time and number of the applications. A slight amount of pain over the affected area in severe cases is often noted from the general methods.

When the temperature has been raised by the treatment, the patient, of course, may feel rather worse—*i.e.*, lassitude, and the sweats on the fall of the fever are sometimes large in amount; also during this period the body-weight may decrease, or, at all events, remain stationary. I found this in many cases where the fever increased; and in spite of the patient

taking presumably a much more nutritious diet, still a slight weekly loss was observed. Some cases will react to the influence of the high-frequency currents within twenty-four hours; others may take a few days. The more severe the case, the more quickly does the reaction take place. However much the temperature rises, it will generally be found down to or at the patient's usual normal within forty-eight hours, so that the dose can be readily regulated, and the patient only given as much as he can comfortably bear. When the patient can be exposed to the currents for over half an hour daily for one week, and it is found that during the whole period the temperature remains steady at normal and subnormal, we may safely predict that the disease is, to say the least of it, arrested. With all these patients the milliampèremeter registered from 150 to 250 milliampères, seldom less; latterly an average of 350 milliampères has been used, and the time five minutes.

The chart shown is a fairly typical temperature in a severe case. For the next three

weeks it never rose over 90°; for the following eight weeks it never rose over normal, and generally was subnormal; then daily observations were stopped. The weight increased 1 pound during the first week, lost 1 pound for next two weeks, then steadily gained 1 to

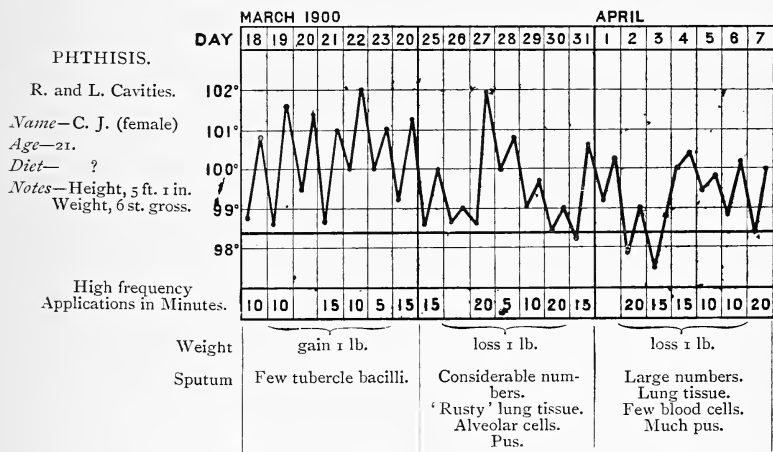

2 pounds for the following eight weeks. During the fourteenth week of treatment from the commencement of 'high frequency' the patient 'put on' 3½ pounds. Her weight (in her clothes) was 6 stone and her height 5 feet 1 inch. During the fourteen weeks' treatment she

gained 1 stone  $4\frac{1}{4}$  pounds. Two months after, with no treatment, she weighed (in clothes) 7 stone 13 pounds, which she has maintained for the last twelve months. The applications were fifty in number, and varied in dose from five to twenty minutes. After the third week twenty-minute doses were given on the average twice a week. In March, 1901, twelve months after, five applications of thirty minutes' duration, given on five consecutive days, could only raise the temperature to  $99^{\circ}$  in the evening and  $98.2^{\circ}$  in the morning. Now one finds that the average dose is ten minutes with the milliamperèmeter registering 300 to 400 milliampères.

Forty cases in all were treated in London, which can at present hardly be considered as a first-class health resort, but I am strongly of opinion that the application of high-frequency electrical currents in sanatoria and like institutions will greatly swell the number of so-called cures. It is a remedy that should only be administered by medical men, as it needs as much care as any other therapeutic agent.

Further information of the original forty-three cases : Three have died ; of the rest, thirty-two have had no treatment of any kind whatever for over eighteen months. Eight cases had on an average two months' treatment each since that time. This year none of them have needed treatment. The majority, who were workers, are performing their usual duties. The three deaths were due to pneumonia, tuberculous kidney, and lardaceous disease.

Briefly, those patients received from ten to twenty minutes' auto-condensation. Eleven of the earlier cases were treated to the effleuve locally over the bared affected area, the operator's unemployed hand being placed in contact with the back of the chest ; but owing to lack of time, etc., this latter method was abandoned. Other workers have experienced such good results that in some cases it would be well to employ general and local means.

Under this treatment they lost their cough and expectoration. The tubercle bacilli disappeared ; but in some a few could be found

months after all treatment had been stopped, yet they seemed in good health. Sometimes their sputum would be without tubercle for months, then a few would reappear for a few weeks, and then, without treatment, disappear again. The bodily weight increased in favourable cases as much as a pound a week.

When many hundreds of these phthisical patients have been subjected to this method we shall be in a position to judge of its merits and compare it with the 'open-air cure,' which at present has not shown such a good percentage of 'arrests.' In my opinion, as a valuable adjunct to a sanatorium, it should afford very material assistance, even in the more severe cases that do not usually gain admittance.

#### DYSPEPSIA.

Dyspepsia of most varieties is greatly improved, as a perusal of the preceding pages will show, gouty dyspepsia being particularly amenable to this form of treatment.

## ATONIC DILATATION OF STOMACH.

Very little has been published on the uses of H.F. currents in this condition, but the few cases one has been able to treat personally have convinced me that we may expect to get great amelioration in the majority of cases. The following case under my care is typical:

A. G., male, aged fifty-six. Had been under considerable medical and other treat-

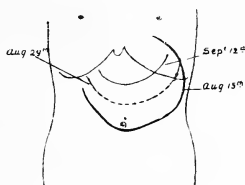

FIG. 73.—DIAGRAM OF ATONIC DILATATION OF STOMACH.

ment for the past fourteen years. Complained specially of no appetite, 'blown-out' sensation of abdomen, feeling of weight after any food, much flatulent dyspepsia, frequent vomiting, and loss of sleep. On examination, it was easily recognised that the stomach was hugely dilated to 1 inch below umbilicus, and extremely resonant over the area shown in diagram. Loud

splashing could be easily elicited; the pulse was weak and slow, but heart normal. The general aspect was that of a confirmed invalid. The local effleuve for five minutes and auto-condensation for ten minutes daily for six weeks. The symptoms gradually, week by week, abated, and the patient gained 4 pounds in weight. He then said he had never felt better. Over a year has elapsed, and he is still well. The stomach is normal in size and function.

The most certain method of mapping out the dilated organ is that suggested by Dr. George Herschell, which consists of the patient swallowing a cachet in which a silver chain a few inches long is carefully coiled up, and attached to it is a strong silken thread. The cachet in the stomach soon dissolves, setting free the chain, which can be readily detected by the X rays, and a few skiagraphs taken in various postures will accurately give the limit of dilatation of that organ.

The above coincides with the series of cases



(seventeen) presented by Drs. Alexander Crombie and T. J. Bokenham, to whom I am indebted for permission to include the subjoined passage in this little book.

They report as follows: 'The highly unsatisfactory and uncertain results of treatment in atonic dilatation of the stomach by the methods ordinarily in use led us to try the effect of rapid oscillatory currents of high voltage in cases of this nature. The details of the seventeen cases we give will show what their character was—*i.e.*, that they were cases of non-obstructive dilatation of the stomach of a duration varying from a few months to fifteen years, marked by dyspeptic symptoms of greater or less severity, and accompanied by neurasthenia of a more or less pronounced kind—from mere "loss of nerve" to profound depression and complete nervous breakdown. In three of our cases the condition seemed to depend for causation on mental strain, and the dilatation of the stomach to be secondary; but how far previously unnoticed dilatation may have contributed to

the result it is impossible for us to say. In all the others the dilatation was probably primary, and due to causes obviously capable of producing this condition, and the neurasthenic symptoms followed as the effect of the defective digestion, malnutrition, and auto-intoxication consequent on the dilatation. That this was the true relationship is rendered probable by the fact that on the reduction of the size of the stomach and the improvement in digestion the neurasthenia disappeared; but in one case (Case 12), in which the reduction of the stomach to its normal dimensions was not followed by improved digestion, there was no amelioration of the neurasthenic symptoms, and, as is well known, there may be a dilated stomach without any neurasthenia, provided the digestion is performed in a fairly satisfactory manner in spite of the dilatation. Moreover, we were repeatedly in a position to demonstrate in the most conclusive manner that the primary effect of the treatment is to reduce the size of the stomach. To demon-

strate this it is only necessary to mark out carefully on the surface the limits of the stomach before and after the application of the current at any sitting, and to do this correctly requires the ability to distinguish slight differences of tone in the percussion note, and to remember that an organ which is partly filled with gas and partly with fluid does not everywhere give the same percussion note. The tympanitic note elicited at the cardiac is very different from the duller sound towards the pyloric end of the stomach. That this has often been forgotten is shown by the figures of dilated stomachs in some text-books, in which they are represented as not extending to the right of the middle line. In advanced cases, when there is a pyloric pouch giving a tympanitic note on percussion, and the duodenum and colon are also at the same time dilated and tympanitic, some difficulty may be found in delimiting the extension of the stomach in this direction, and then the simultaneous use of a binaural stethoscope, placed alternately within and beyond the

supposed limits of the stomach, and light tapping with the end of the marking pencil, will resolve the difficulty. It often facilitates matters to inflate the stomach by a draught of aerated water to bring out the tympanitic note more clearly. By the exercise of similar care the position of the colon, and even of the duodenum, can be made out. In most cases a certain amount of displacement of the transverse colon could be detected. In some of those described below there was very distinct intestinal ptosis; this seemed to make no difference in the final result.

‘ Having in this way carefully marked on the surface the limits of the dilated stomach before the application of the electrode, if this is done again immediately after the treatment the stomach will be found to have receded from  $\frac{1}{2}$  to  $\frac{3}{4}$  inch in all directions. This result was invariable, and we know of no effect of any remedial agent in the whole domain of practical medicine which is so certain and so conclusively demonstrable of this retrocession of a dilated

---

stomach on the application of a high-frequency current. This is not accompanied by any altered sensation on the part of the patient, who at the time feels nothing, though he is naturally conscious, after a few sittings, of being "tucked up" as the retrocession of the stomach proceeds and the process of digestion improves. After a number of applications, varying in different cases from ten to twenty, the stomach was found to have assumed its normal position and size, and the other parts of the intestinal tract to have returned to their natural relative positions. At the same time, in all but two of our patients the normal process of digestion was restored, but it was considered advisable to continue the dietary regimen for some time longer. There was a short relapse of indigestion in one case and of redilatation in another after dietetic indiscretions. In one there was no improvement in digestion, owing apparently to a radical fault in the gastric juice (hypochlorhydria), although the stomach remained of normal size. This patient is slowly

improving under treatment conducted on general principles, and his stomach continued normal in size and position for at least six weeks after the electric treatment was discontinued. Whether the effect in this and the other cases will be permanent, with the necessary precautions as to diet, it is, of course, impossible at present to say, but we venture to assert that such results as we have obtained in fifteen of our cases would not have been possible with the means of treatment usually employed in this troublesome condition in the same time and with so little difficulty.

‘Our experience of this treatment leads us to think that the immediate, and possibly the only, effect of the high-frequency applications is to give tone directly, or indirectly through the vagus, to the unstriped fibres which constitute the muscular walls of the stomach, and that this “toning up” enables them to contract and to diminish the size of the organ. The improvement in digestion which follows is probably the result of the restoration of a more

---

normal condition of the circulation and blood-supply to the gastric glands, consequent on the return of the stomach to its natural size and position. It is not apparently due to any special stimulation of the gastric glands, because in those cases in which there is a radical fault in the secretion no improvement in this respect follows the reduction of the dimensions of the stomach, although the electric treatment is continued. The tone given to the unstriped muscular fibres enables the stomach to empty itself after each meal, and the retention of imperfectly digested food ceases, and with this the absorption of abnormal products of digestion and the consequent symptoms of auto-intoxication and neurasthenia. Further experience may, however, modify this view of the action in cases of the high-frequency current, an agency of which the potency and mode of action are at present so little known. Besides the (usually) daily application of the high-frequency current, all these cases were placed on a diet calculated to

reduce the difficulties with which a dilated stomach has to deal. The amount of fluid taken with meals was reduced to a minimum, and articles of diet of acknowledged difficulty of digestion were forbidden, but without any reduction in the nutritive value of the dietary. This was the "dry diet" referred to in our cases. The necessary amount of fluid required by the organism was taken in the form of hot water less than three-quarters of an hour before meals. It will be noticed that this diet had been continued in some instances for some time; in one case six months, with only slight benefit, before the commencement of electrical treatment, and that marked improvement immediately followed the use of the high-frequency current, with a practical and so far permanent "cure" in a few weeks. In stout people there was, as a rule, distinct loss of weight during the continuance of the treatment, but the thin and emaciated gained weight steadily. In only one case was it thought advisable to resort to lavage after beginning the treatment.



‘In the early cases treated the patient was placed on a couch, and the region of the stomach was “sprayed” by a brush electrode held at a distance just beyond that at which a direct spark would pass between the electrode and the skin. The effect experienced was described as similar to the dropping of a shower of warm sand on to the skin, and after a few minutes peristaltic movements of the stomach would often be distinctly felt.

‘A very convenient condenser electrode can be made by filling a large flat-bottomed flask with salt-water, and passing a wire through an indiarubber cork fitted to its neck, the free end of the wire being connected to the resonator. With such an arrangement the effect is, perhaps, more exactly localized to the region it is desired to influence. Another method is by a lead foil electrode of such a size as to cover the whole gastric area; close contact is secured by interposing a layer of wet flannel between the metal and the skin. With this the patient usually feels scarcely anything

over the area of application, and the quantity of the charge depends upon the electro-static capacity of the individual. The effect of the application is in most cases highly invigorating.'

#### COLITIS.

Innumerable cases have been reported by Continental observers on the efficacy of these currents in this and allied conditions. At all ages one seems to get most excellent results. Auto-condensation has been chiefly used, but locally the glass condenser electrode appears to assist very materially.

The 'stable method' with a large abdominal electrode is a good proceeding.

## CHAPTER VIII

### SOME LOCAL DISEASES

LUPUS VULGARIS—LUPUS ERYTHEMATOSUS—CHRONIC  
ECZEMA — ACNE ROSACEA — PITYRIASIS — PSORIASIS —  
SCIATICA — HEADACHES — NEURALGIAS — WARTS — HÆ-  
MORRHOIDS—FISSURE OF ANUS—PROLAPSE OF RECTUM  
—PRURITUS — SIMPLE ULCERS — RODENT ULCER —  
MALIGNANT GROWTHS — TRACHOMA — EXTRACT OF  
DR. FREUND'S PAPER ON HIGH-FREQUENCY METHODS



## CHAPTER VIII

### SOME LOCAL DISEASES

#### LUPUS VULGARIS.

TUBERCULAR skin affections, such as lupus vulgaris, may be best treated by means of general electrification, together with the effleuve locally. Dose generally ten minutes of the former to five minutes of the latter. At the actual time little may be noticed, but the patient may feel some warmth in the patch, which increases for a few hours afterwards. Sometimes the reaction, when seen on the following day, is too severe to touch ; one then has to wait for a subsidence. The patch swells up and then becomes very succulent ; secretion quickly stops. The resultant scar depends on the amount of original ulceration at the commencement, or maybe upon the too

severe reactions produced. Most non-ulcerative patches will leave no scar. In my experience it is much quicker and more under control than with the X rays. At the West London Hospital we are able to clear up an average non-ulcerative small patch in about twenty applications of five minutes, sitting two days a week.

With H.F. effleuve the number of applications is about one-third, and the whole of one side of the face can be treated at a time, the patient's sensation being that of receiving a soft warm breeze. Actual sparking I have seldom found necessary. It is unnecessary to use any application to increase or keep up the action of these currents. Using a glass low-vacuum electrode in actual contact with the lupus patch is, in my opinion, an effective, and to the patient an almost sensationless, method of application.

*Case I.*—R. H., girl, aged eight years. Lupus vulgaris,  $2\frac{1}{2}$  inches by 1 inch, left cheek; duration, three years and two months. Arrested by

means of general treatment by auto-condensation. Twenty-eight sittings of about ten minutes each. Scar still brownish after nine months, but thin and smooth.

*Case II.*—E. G., girl, aged six years. Lupus vulgaris ; a linear patch  $1\frac{1}{4}$  inches, right neck under angle of jaw ; duration, nine months. Effleuve to sole of bare foot ; about thirty applications of about five minutes. The patch being an ulcerated one, a linear, puckered, dense scar has resulted. No return for two years. The best treatment is undoubtedly by both general and local means, in the latter using a glass vacuum electrode in actual contact, and more or less withdrawn if a powerful action is required.

The two cases cited are intended to suggest that with purely local treatment we are generally electrifying the patient, but of course not to such a degree as with auto-condensation and auto-conduction. The majority of the patients were of the poor class, and the general treatment, I am convinced, helped in a very material manner to arrest the condition.

## LUPUS ERYTHEMATOSUS.

The following case is interesting, as showing the good effects of combined general and local treatment :

Patient, J. E., female, aged thirty-two. Condition had first appeared bilaterally at twenty-one. For many years had had ointments, lotions, and caustics ; frequent scarifications. Finsen light seven months, from half to one hour sittings ; average, three times weekly. With local H.F. effleuve, five to ten minutes' bi-weekly applications, materially improved, but slowly, for four months. I then gave an equal time of general treatment each sitting, and the result was much hastened. After eight months in all the patch produced a fine, smooth, whitish-pink scar, practically level with the surrounding skin. One year has elapsed, and her scar is much finer and almost normal in colour.



## CHRONIC ECZEMA.

This condition is best treated with the glass vacuum electrode in actual contact and auto-condensation, and later by the labile method. The reactions may be somewhat violent, and must be carefully watched.

## ACNE ROSACEA AND PITYRIASIS.

These are skin conditions in which the greatest benefit has resulted from H.F. treatment.

## PSORIASIS.

In one severe case of palmar psoriasis, which had resisted various treatments for over two years, the effleuve for eleven sittings of five minutes sufficed to clear up the trouble. The palms have remained well for past eighteen months. There was a specific history, and antispecific drugs had been extensively tried.

## SCIATICA.

If the pain be severe, a few treatments by auto-conduction; if bearable, the

effleuve to exit and down the course of the sciatic nerve. Both methods for the first few applications may increase the pain, but eventually should clear it up, even in cases of long duration. Auto-condensation seems to increase the pain more than auto-conduction.

#### HEADACHES.

Most forms are distinctly benefited by either condensation or conduction. The sounds from the spark-gap should be dulled as much as possible.

#### NEURALGIAS.

My experience has mostly been with those situated on the face. Treatment by auto-condensation for about five minutes, and the effleuve to the affected part for a like time, or the glass electrode in actual contact, but with a mild amount of current, is a most effectual method.

#### WARTS.

By using a small pointed metallic electrode (H, Fig. 74), using its effleuve and gradually lessening the distance until the wart itself is

sparked, usually about half a dozen applications are necessary; but if the patient will stand a little pain the wart can be made to practically slough out at one sitting. The resultant sore heals very quickly, leaving hardly any scar.

### HÆMORRHOIDS,

if of long standing and external, are somewhat slow to respond to the stimulation of

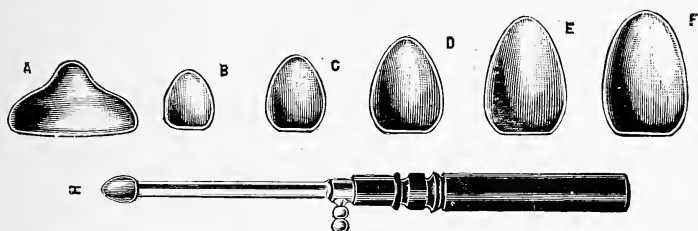

FIG. 74.—HÆMORRHOID ELECTRODES.

local treatment. The effleuve or mild sparking should be tried if external, but if protrudable they are more readily amenable to the treatment. Internal ones high up can be easily treated by olive metal electrodes (as B to F, Fig. 74); generally ten minutes each sitting and about thirty applications are

necessary. General treatment by auto-condensation or conduction seems to assist very materially in most cases.

The above remarks, of course, only apply to those patients who, from age or other cause, refuse operation.

#### FISSURE OF ANUS.

This condition may be benefited, but is most probably due to the mechanical stretching that must ensue to treat it efficiently.

#### PROLAPSE OF RECTUM.

May be generally relieved by the effleuve, and after a time actual sparking. Electrode A, Fig. 74, is the most efficient one.

#### PRURITUS ANI.

This condition has yielded most excellent results, responding to any form of local H.F. treatment. Electrode K, Fig. 42.

#### SIMPLE OR CALLOUS ULCERS.

These are stimulated to heal with great facility and rapidity by the application of the effleuve,

given preferably through a low-vacuum glass electrode in actual contact.

### RODENT ULCER.

The effleuve can be readily applied, and is in all cases most effectual. In one case, in which the growth had returned after operation nine months previously, I used my thumb as an electrode, the patient being on the auto-condensation couch and connected to one pole; the other was connected to myself, and the circuit completed by my thumb on the ulcer. At the end of the first three applications the dry serum, etc., became attached to my thumb; one could feel it getting loose after a few minutes, owing to serous exudation from the deeper parts. Each application seemed to shrink the ulcer up.

The hard edges were most resistant, but have now entirely disappeared. This patient has had no treatment for or trouble with it for eleven months. For large ulcers a glass electrode in actual contact seems to be the best

form of procedure. The application is, of course, practically painless, and the cosmetic effects most excellent. Relapse is said to be of rare occurrence.

#### MALIGNANT GROWTHS.

My experience, though small, has led me to believe that these currents, in suitable cases, will prove of some benefit. Thus in several post-operative recurrent cases under my own care the ulceration has healed up in a very remarkable way, but the growth in other parts has persisted. In one case, after the third operation on the right mamma, the growth returned in considerable masses all round the part. During two months' treatment they were slightly reduced in size, and became of 'stony hardness' and quite painless, but the patient succumbed to secondary deposits in the lungs and liver.

I am indebted to Dr. James Allan (Chislehurst) for the following interesting cases, which are illustrative of the effects that may be produced by this form of treatment :

---

*Case 1.*—Miss H., aged forty-eight. This lady was operated upon in August, 1899, for sarcoma of the antrum, which invaded the nasal cavity. There had been a very free operation performed, and the greater part of the nasal septum had been removed. There was a recurrence in August, 1900, and some further growth was removed under cocaine. In July, 1901, there was a further recurrence, with much dragging pain, which prevented her from sleeping. She was advised that a further operation was necessary, and that it would be a very serious one. Her sister had died two years previously after a similar operation. As the patient did not care to have further operative measures, she came to me for treatment by the high-frequency method. The growth was easily seen in the nasal passages. The patient looked very ill, and complained of much pain. I applied the current by means of a small condenser electrode passed into the nostril for fifteen minutes each sitting, using a primary energy of 5 ampères. After the second application the pain began to

subside, and the growth to become less. The patient felt better, and slept well. In all, the patient had fifteen sittings, at the end of which time the visible growth had disappeared, and the pain entirely gone. The lady returned to her home in the country, and has since had no recurrence. The pathological report on the growth was a spindle-celled sarcoma.

*Case 2.*—Mrs. H., aged thirty-seven. This lady returned from India in 1901, after a residence there of many years. She had a tumour in the right breast, which caused her some anxiety, and she consulted an eminent London surgeon. He diagnosed carcinoma, and recommended operation. This was acted upon, and in November, 1901, he removed the breast and cleared out the axilla very freely. The diagnosis was amply confirmed at the operation, and a very bad prognosis given. Three weeks after the operation I started the high-frequency treatment locally by the unipolar method, using a primary energy of



5 ampères. The patient's weight was then 9 stone 9 pounds.

The appetite speedily returned, and the patient felt much better. There is no sign of recurrence now—four months after the operation—and the patient is in splendid health and able to enjoy herself thoroughly. She has had thirty applications, ten minutes each sitting. Her present weight is 10 stone 1 pound.

*Case 3.*—Mrs. A., aged sixty-three. This lady is a patient of Dr. Crombie's, of Sidcup. On August 27, 1901, she had her left breast excised for scirrhus. The wound healed by first intention, and she was able to be out in six weeks. Two months after the operation signs of recurrence began. The supraclavicular glands became painful, with much induration along the cicatrix and tenderness in the axilla. She was sent to me for high-frequency treatment by Dr. Crombie on November 2, 1901. I applied the unipolar treatment locally for fifteen minutes each sitting, using a primary energy of  $3\frac{1}{2}$  ampères. After the fourth

application the pain began to subside and the hard indurated parts to soften. The patient's general condition improved rapidly, sleep returned, and the appetite was described by the patient herself as ravenous. After twenty-eight applications all trace of the recurrence had disappeared, but the patient insisted on continuing the treatment, as she felt so much better for it, and she has had in all forty-eight sittings.

*Case 4.*—Mrs. C. R.; epithelioma of the cervix. This lady came under my care on November 8, 1901, after her case had been given up as hopeless by two different doctors. She was known to have had the disease for eleven months. She was seen in consultation with me by Dr. Drummond Robinson and Dr. Crombie, and it was decided that the case was too far advanced for operation, and that unless the high-frequency treatment could arrest the disease, it must take its course. The cervix was completely involved.

The patient was thin and emaciated, weighing 6 stone 5 pounds, and looked and felt very

ill. As the case was a desperate one, I determined to push the treatment much further than I had ever done before, and gave the patient from forty to sixty minutes' treatment daily, using a primary energy of  $5\frac{1}{2}$  ampères. A unipolar or condenser electrode was passed into the vagina and made to impinge against the growth. This speedily wrought its way through the friable tissues of the cervix, and at present the instrument passes freely into the uterine cavity. The treatment was continued daily up to January 2 of this year, when a very severe reaction set in. The patient had several rigors, and became very ill indeed, and for several days hung between life and death. She gradually recovered under treatment, and the high frequency was resumed on January 28. After the first week's treatment signs of improvement became evident. The pain decreased, as also did the discharge. The patient slept well, and the appetite improved. The local condition did not alter much, but the general condition rapidly improved. At present the growth

seems to be entirely arrested. The patient feels very comfortable and looks very well. Her weight has increased from 6 stone 5 pounds to 7 stone 10 pounds.

That the most part, if not all, of the pain can be banished is a fact, so that the patient can be freed from morphia, etc. ; also the general condition of the patient can be materially improved (see Appendix A.).

#### TRACHOMA OR GRANULAR LIDS.

From the very limited experience of this condition one can only remark that one found auto-conduction about ten minutes and the glass vacuum electrode applied outside the lids for five minutes to be very efficacious. Fifteen to twenty sittings were needed, spread over a period of two months. The following instructive note is reprinted from the *Lancet* of January 24, 1903, by kind permission of Drs. Sydney Stephenson and David Walsh :

*'Short Note on the Cure of Trachoma by X-ray Tube Exposure and by High-frequency*

*Brush Discharges.*—Trachoma, or “granular lids,” as is well known, is a formidable and obstinate contagious malady that, even in the most experienced hands, can rarely be cured within one or two years. Any remedy, therefore, that shortens the period of treatment to weeks must claim widespread and earnest attention. We believe that such a curative agent exists in two forms of electrical discharge—first, that given off by the X-ray focus-tube; and, secondly, the brush discharge obtained from a D’Arsonval high-frequency apparatus. One case of the treatment of trachoma by focus-tube exposure has been reported by Mr. M. S. Mayou.\* We have treated a single eye in four cases of severe bilateral trachoma in children. Two eyes were cured—that is to say, the granulations and conjunctival hypertrophy disappeared, and have not returned after a period of several months. The remaining two eyes were greatly benefited, and were

\* *Transactions of the Ophthalmological Society*, vol. xxii., 1902.

well on the road to ultimate cure. The cures were effected by seventeen exposures in the one case and by six in the other, with an average exposure of ten minutes and a distance of about 8 inches of the anticathode from the lid. The good effects were found to be equally marked with closed as with everted eyelids. Twenty-two applications of a mild high-frequency brush, applied by means of a vulcanite electrode connected with a D'Arsonval apparatus, cured a severe case of trachoma in another patient.

‘The radiotherapy of trachoma presents several obvious advantages over the ordinary treatment by escharotics—as, for example, its painlessness, its great rapidity, and its simplicity. The fact that a severe malady like trachoma (which has led to the expenditure of many thousands of pounds of public money in this country alone) can be cured by exposure to an active focus-tube and to a high-frequency brush suggests that the curative agency may be identical in both instances. This observa-

tion may possibly throw fresh light on the therapeutic action of the focus-tube, a point about which little is really known. The common agency may be a brush discharge, visible from the high-frequency electrode and invisible from the focus-tube. In any case, the introduction of new and powerful methods of treating trachoma must have an important bearing upon the victims of ophthalmia in many countries.'

DR. FREUND'S OPINIONS ON X RAY, H.F.,  
AND LIGHT TREATMENT.

At the British Medical Association Annual Meeting, held in Manchester, 1902, in the Dermatological section, an abstract of a very interesting paper was read by Dr. Lancashire (secretary of the section), in the unavoidable absence of Dr. Freund (Vienna). Freund and Schiff were the chief pioneers of the treatment of skin diseases by means of the X rays, and as such their observations are worthy of great consideration. In the above

abstract some very peculiar statements regarding high-frequency methods were given, as the following paragraphs will show. The numbers refer to the original abstract :

‘6. D’Arsonvalization can be included in radiotherapy. The author believes that the physiological effects of this method are solely due to the spark discharges accompanying the use of the apparatus.’

This is somewhat contrary to my experience, as will be seen under lupus vulgaris treated by general electrification and with the effleuve to a distant part.

‘7. All spark discharges may cause physiological effects, which may result from (*a*) the mechanical bombardment of the tissues, (*b*) the production of heat, (*c*) chemical effects by the formation of ozone, (*d*) ultra-violet ray formation.’

Regarding (*b*), inflammatory heating of the tissues is necessary for a cure ; (*c*) formation of ozone—the effects of this on skin diseases must be extremely small ; (*d*) the solution is in every



probability to be found in the ultra-violet formation.

'9. D'Arsonvalization is useful in the various forms of pruritus, also in lupus erythematosus, and to produce the exfoliation in pityriasis versicolor, acne vulgaris, rosacea, pigmentary abnormalities; favourable effects also in fissura ani, probably through the desquamation. (2) The action of D'Arsonval's apparatus is superficial only, and due only to the accompanying spark discharge.'

(1) May not the mechanical stretching to reach the base of the fissure have something to do with the cure?

(2) Again, see report of case under Lupus Vulgaris.

'10. A single spark apparatus. A test-tube filled with water, and connected with the negative pole of a coil, the positive pole being earthed. With this apparatus brush discharges can be obtained equal to those of Oudin's apparatus. The brush discharge is useful for widespread areas of disease and in the case of

nervous people. Spark discharges can be applied to more circumscribed areas. Treatment with the "electrified hand," another spark method, but a very mild one.'

Having tried the above, one cannot easily understand how the brush discharges can be likened in efficiency to those obtained from Oudin's or other similar apparatus. It is difficult to ascertain if by spark discharge Freund means *effleuve*; if the latter, his statement will meet with general assent by H.F. workers. The 'electrified hand' is in great vogue by certain unscrupulous practitioners on the Continent, chiefly in Paris. It is the favourite method employed by 'quacks,' and is the most showy, but will be seldom employed in this country. It is extremely mild, and other methods are much superior. The paper, which was intended to open a discussion on X-ray treatment, the high-frequency method, and light treatment, was naturally robbed of a great deal of its value by Dr. Freund's absence.

## APPENDIX

### A.

DR. JAMES ALLAN has kindly furnished me with the following after-history of the four cases reported on pp. 199 to 204, up to the date March 27, 1903 :

*Case 1: SARCOMA OF ANTRUM.* — Writes that she is feeling very well and has had no recurrence.

*Case 2: MAMMARY CARCINOMA.* — There were slight signs of recurrence in October, 1902, which I removed, and at the same time did double oöphorectomy; there is no sign of further trouble, and the patient is in splendid health and increasing in weight.

*Case 3: SCHIRRUS.*—No recurrence.

*Case 4: EPITHELIOMA OF UTERUS.*—This patient contracted pneumonia, which ended fatally. The condition of growth was much improved; complete absence of pain and discomfort.

Dr. Allan concludes: "I fear to claim them as cures, as the time is much too short to allow one to judge."

## B.—CHRONIC TUBERCULAR SINUSES.

The following case, reported in the *West London Medical Journal*, April, 1903, is extremely interesting from an electro-therapeutic point of view. I am indebted to Mr. McAdam Eccles for permission to include it in this little book.

### A CASE OF TUBERCULOSIS OF THE URINO-GENITAL TRACT, EXHIBITING SOME POINTS OF INTEREST.

The following case presents several interesting aspects:

A gentleman, aged thirty-seven, a responsible officer in a Government department, was seen by me, in consultation with Mr. T. Rushbrooke, in December, 1900, for a swelling in the right loin. Ten months previously he had experienced on one or two occasions sharp pain in the right iliac fossa, which, however, had not caused his absence from his office. Some years prior to this he had been rejected for life assurance on account of slight albumin in the urine and some degree of rapidity of the pulse-rate.

On examination he was found to be a tall, spare man, with reddish hair and beard. His weight was 9 st. 10 lb. His chest was well shaped, with good expansion, normal resonance, and there were no added breath-sounds. His pulse-rate was 80, and there was no evidence of any cardiac lesion.

His abdomen, as seen from the front, was not

distended, and it appeared from this aspect to be quite symmetrical. It moved well on respiration, and there was no area of pain or tenderness. On palpation, however, the right rectus was found to be held more rigid than the left, and a distinct rounded tumour could be made out, occupying a space reaching from the right costal arch to the level of the right anterior superior spine of the ilium, but not encroaching beyond the middle line. The abdominal wall moved well over the swelling, and the tumour itself did not shift its position on the descent of the diaphragm. There was a resonant note over it up to the liver dulness. The swelling, though elastic, did not definitely fluctuate. In the right lumbar region, filling up the space between the last rib and the crest of the ilium, there was a swelling, projecting above the surface of the skin to the same extent as would half an orange. It was dull on percussion, and exhibited marked fluctuation. The same sign could also be obtained bimanually through the swelling in front. His temperature was normal. He was passing 50 ounces of urine in the twenty-four hours, micturating some four times during the day, and having to rise once at night for the same purpose. There was no pain on defæcation, nor tenderness about the prostate or vesicles. The urine, on examination, was found to be faintly alkaline, of a specific gravity of 1,023; there was present in it a minute trace of albumin, but no blood or sugar, and the urea was 9.7 grains to the ounce. By the microscope a few stellar phosphates were observed, but no pus cells or bacteria. The diagnosis was

somewhat obscure, but it was considered probable that the case was one of renal tuberculosis, or of a chronic suppuration in connection with the vermiform appendix.

In December, 1900, operation was advised. Accordingly, on December 18 the patient was put under the influence of chloroform, and an incision some three and a half inches in length was made over the lumbar swelling, until a large cavity, containing 15 ounces of thin, inodorous pus, was reached. A finger introduced into the cavity showed that it was retroperitoneal, but I could not determine the viscus with which it was associated. It was decided not to explore any further at the time, and the abscess was drained. An examination of the pus for bacteria proved that it was sterile.

The patient made good progress so far as general condition went, gaining in weight and having an excellent appetite. The opening in the loin, however, refused to heal, and degenerated into a sinus. He was sent away to the seaside, where he continued to improve, but the sinus persisted practically the same in length and appearance.

On April 30, 1901, I freely opened up the sinus, and scraped it thoroughly out, and found no cause for its failure to heal. Again the sinus re-formed, with no attempt at proper closing. It, however, showed no signs of irritation, there being no sentinel granulation tissue, and the little discharge that there was from it was quite of a serous nature. The urine was normal, and the body weight maintained.

On July 2 I saw him in consultation with Mr. Bowlby, and we agreed that it would be right that he should try the effects of a residence on the east coast. He accordingly spent the summer away, but when seen again on October 28 there was no evidence that any real healing had taken place. He was then submitted to the X rays, and the skiagram showed a shadow of fairly definite outline in the region of the right kidney. This was thought to indicate that there was a calculus present, and to suggest an exploration. Therefore, on November 14, with the kind assistance of Mr. Bowlby and Mr. Rushbrooke, I operated. The patient was placed under the influence of ether, and the operation lasted forty-five minutes. A fresh incision was made in the loin at a higher level than that employed for the opening of the abscess. When this had been deepened it revealed an entirely disorganized kidney, about half the size of a normal organ, and having its interior filled with pultaceous material, evidently of a tuberculous nature. The whole was excised, silk being used to tie the pedicle, although there was little or no real vascular supply to the useless kidney. No attempt was made to explore the ureter with a sound. The lower sinus was again scraped out, and the upper wound closed.

Two days after the nephrectomy the patient developed a high temperature, with consolidation at the base of the right lung, much dyspnoea and cyanosis. Dr. William Hunter saw him with me, and for several days he was desperately ill, in spite

of the treatment adopted, although this in the end brought him out of danger.

The upper wound would not heal, neither would the sinus of the original operation wound. When able, he went again to the seaside, the lung mischief having apparently entirely subsided. Once more his general condition greatly improved, but the two sinuses which were now present refused to heal.

In May, 1902, he returned to his duties in the department, and continued them without much inconvenience until September, when he noticed a small nodule in the lower part of the *left* epididymis. It was decided to watch this, and for three months there was no appreciable difference in it.

All this time he maintained his weight at a higher level than he had ever known it previously, and in general health he had greatly improved. The sinuses persisted nevertheless. On December 13, 1902, it was determined to try the effect of the high-frequency currents upon them, and accordingly Mr. Chisholm Williams was kind enough to apply these. Locally, a glass vacuum electrode in actual contact for five minutes and ten minutes' auto-condensation was used daily. At first there was but little improvement, but after some *four weeks* a distinct change for the better began and steadily progressed.

On January 26, 1903, however, he developed a marked hydrocele in the right half of the scrotum, and the right epididymis was now found to be affected,



the nodule in the left remaining much the same as when first observed.

In March, seeing that there was no improvement in the local condition of the testes, but a steady increase in the mischief on the right side, I advised that a removal of the right, and probably of the left gland as well, should be performed. An independent opinion as to the condition of his lungs was given by Dr. F. T. Roberts, who could find no evidence of past or present disease, and certainly no contra-indication to operation. Sir Frederick Treves also saw him and counselled operation, suggesting that complete castration should be performed on the right side and removal of the diseased portion of the epididymis on the left. On March 18 he was placed under the influence of ether, followed as soon as he was unconscious by chloroform, and I removed, with Mr. Rushbrooke's help, the right testis, dividing the vas at the level of the deep abdominal ring. I then cut down upon the left testis and dissected the whole of the epididymis away, but left the body of the organ intact. On examination *per rectum*, the prostate and vesicles while under the anæsthetic failed to reveal that they were the seat of disease. Both wounds healed rapidly, and the patient left the Nursing Home for the seaside on March 30, both scars being sound, and the wounds in the loin practically in the same condition.

*Remarks by Mr. Eccles.*—The case exhibits many points of interest, chief among which may be mentioned the insidious onset of the renal mischief, *the*

*persistence of the sinuses even after removal of the kidney, the pneumonia following the nephrectomy, the affection of the left epididymis first and apparently without bladder or prostatic trouble, the rapid healing of the castration and other scrotal wound, and the progressive healing of the loin sinuses following the high-frequency treatment after these had remained open for two years.*

## INDEX

- ACCUMULATORS or storage batteries, 24  
 advantages, 26  
 capacity, 26  
 charging from dynamo, 26  
   from main, 27  
   from thermopile, 29
- Acne rosacea, 193
- Allan, Dr. James, 199, and Appendix A.
- Alternating current, 32
- Ampère, 17
- Anæmia, 165
- Ani, pruritus, 196
- Applications of H.F.C., 123  
 auto-condensation, 134  
 auto-conduction, 130  
   direct, 123  
   duration of, 126  
   labile, 126  
   local, 138  
   stabile, 125
- Atonic dilatation of stomach, 175
- Author's electrodes, 87
- Auto-condensation, couch for, 77, 135
- Auto-conduction, cages for, 80, 130
- Batten, Dr., rectifier, 35
- Batteries, bichromate, 22  
   Bunsen, 23  
   Edison Lalande, 23  
   electrical, 14  
   Leclanché, 16
- Batteries, primary, 16  
   secondary, accumulators, 24
- Bipolar resonator, 144
- British Electro-Therapeutic Society, 10
- Brush discharges or efflevers, 84
- Cages for auto-conduction, 80, 130
- Callous ulcers, 196
- Cancer, cure of, 10  
 treatment of, 198
- Capacity of accumulators, 26
- Charging, 26
- Cells, 14  
   bichromate, 22  
   Bunsen, 23  
   Edison Lalande, 23  
   Grove, 23  
   Leclanché, 16  
   parallel, 20  
   Planté, 23  
   primary, 16  
   secondary, 24  
   series, 19
- Chlorosis, 165
- Chronic rheumatism, 162  
 eczema 193
- Coil, condenser, 53  
 construction, 47  
 induction, 49  
 primary, 50  
 principles, 47  
 secondary, 51  
 Tesla, 34

- Condenser and solenoid, Gaiffe's, 148  
 Couch for auto-condensation, 77, 135  
 Current, continuous, 30  
   alternating, 32  
   high-frequency, 65  
   transformer, 31
- D'Arsonval's bi-polar resonator, 147  
 and Charrin on sterilizing action of H.F. currents, 119  
   experiment, 114  
   H.F. theory, 116  
   inhibition theory, 118  
   muscular contraction phenomena, 8
- Dean's double resonator, 73  
 Denoyès and Lagriffoul, action of H.F. on tubercle, 119  
 Diabetes, 158  
 Dilatation of stomach, 175  
 Dimitriewski, M., action of H.F. on toxins, 119  
 Diseases, some general, 159  
   local, 187  
 Doumer electrode, 154  
 Ducretet's apparatus, 97  
 Duration of applications, 126  
 Dynamic properties, 102  
 Dyspepsia, 174
- Eccles, McAdam, Appendix B.  
 Eczema, chronic, 193  
 Effleuve, 138  
 Effleuers, 84, 139  
 Electrical batteries, 14  
   machines, static, 43  
   light mains, 30  
 Electrodes, author's, 87  
   Doumer's, 154  
   ebonite spinal, 155  
   glass vacuum, 155  
   hæmorrhoid, 195  
   Hall-Edwards, 150  
   Herschell's, 152
- Electrodes, Hurry Fenwick, 154  
   Tesla's, 86  
 Electrolytic interrupter, 60  
 Electro-motive force (E.M.F.), 15  
 Electro-static properties, 99  
 Energy, source of, 13
- Faraday, 47  
 Fedderson, 7  
 Fenwick, Hurry, electrodes, 154  
 Fissure of anus, 196  
 Force, electro-motive, 15  
 Freund (Vienna), 207
- Gaiffe's bi-polar coil, 144  
   condenser and solenoid, 148  
 Galvanic cells, 14  
 Galvanoscopic foot of frog, 8  
 Geissler tubes, 108  
 Glass electrodes, 155  
 Gout, 161  
 Growths, malignant, 198, and Appendix A.  
 Granular lids, 204
- Hæmorrhoids, 195  
 Hall-Edwards electrodes, 150  
 Headache, 194  
 Hedley, W. S., 134  
 Helmholtz, 7  
 Henry, Joseph, 6  
 Herschell's electrodes, 152  
 Hertz, 7, 66  
   and Oliver Lodge, 9  
   resonator, 106  
 High-frequency currents, experiment with, 94  
   physical properties of, 93  
 History, 6  
 Holtz machine, 7  
 Hurry Fenwick electrodes, 154  
 Hysteria, 164
- Induction coil, 47  
 Innocuousness of H.F. currents, 117  
 Interrupters, dipper mercury, 56

- Interrupters, hammer, 54  
     Mackenzie Davidson, 61  
     mercury jet, Isenthal, 55  
     synchronous, 34  
     Wehnelt electrolytic, 62  
 Introduction, 3  
 Isenthal's resonator, 142  
  
 Jones, Lewis, 114  
 Joubert, 8  
  
 Kelvin, Lord, 7  
  
 Labile method, 126  
 Lagriffoul and Denoyès, action  
     of H.F. on tubercle, 120  
 Leclanché cell, 16  
 Lenz's law, 48  
 Lodge, Oliver, 7  
     and Hertz, 9  
 Lupus erythematosus, 192  
     vulgaris, 189  
  
 Mackenzie Davidson's inter-  
     rupter, 61  
 Magnetic field, 51  
 Mains, electric light, 30  
 Malignant growths, 198, and  
     Appendix A.  
 Management of resonators, 141  
 Mayou, M. S., 205  
 Methods of using H.F. currents,  
     123  
     of auto-condensation, 134  
     of auto-conduction, 130  
         direct, 123  
         labile, 126  
         stabile, 125  
         local, 138  
 Milliampère, 18  
 Milliampèremeter, 81  
 Morton, Wm. James, 7  
 Muscular contraction pheno-  
     mena, 8  
  
 Neuralgias, 194  
 Neurasthenia, 166  
 Nodon valve, 38  
  
 Obesity, 164  
  
 Ohm, 17  
 Ohm's law, 18  
 Oudin, 9  
 Oudin-Dean resonator, 69  
  
 Physical properties of H.F.,  
     93  
 Physiological properties of H.F.,  
     113  
 Pityriasis, 193  
 I lanté, 23  
 Polarization, 16  
 Primary batteries, 16  
     coil, 49  
 Prolapse of rectum, 196  
 Pruritus ani, 196  
 Pulmonary tuberculosis, 166  
  
 Rectifier, Dr. Batten's, 35  
 Rectum, prolapse of, 196  
 Resistance, un t of, 17  
 Resonance, 105  
 Resonators, D'Arsonval, 147  
     Gaiffe's bi-polar, 144  
     Hertz, 106  
     Isenthal, 142  
     Oudin-Dean, 69  
     Rochfort's bi-polar, 144  
     small, 77  
 Rheostat, 31  
 Rheumatism, chronic, 162  
 Rodent ulcer, 197  
  
 Sciatica, 193  
 Secondary coil, 51  
 Simple ulcers, 196  
 Spinal electrode, 155  
 Stabile method, 125  
 Static machine, 43  
 Stephenson, Sydney, 204  
 Sterilizing action of H.F., 119  
 Stomach, atonic, dilatation of,  
     175  
 Sudnik, 129  
  
 Tesla, Nikola, 9  
     electrodes, 86  
     experiment, 102  
 Therapeutic methods, 123  
 Thermopile, 29

- 
- |  |  |
|--|--|
| Toepler-Holtz static machine,<br>44<br>Trachoma, 204<br>Transformers, 31<br>Nodon valve, 35<br>' step-up,' 33<br>Toxins, 119<br><br>Ulcers, callous, 196<br>simple, 196<br>rodent, 197<br>Unit, 16<br>Board of Trade, 19 | Vacuum electrode, 155<br>Valve, Nodon, 38<br>Volt, 16<br>Voltmeter, 28<br><br>Walsh, David, 204<br>Ward and Spottiswoode, 8<br>Warts, 194<br>Water analogy, 17<br>Watt, 18<br>Wehnelt interrupter, 62<br>Williams, Chisholm, electrodes,<br>87 |
|--|--|

THE END







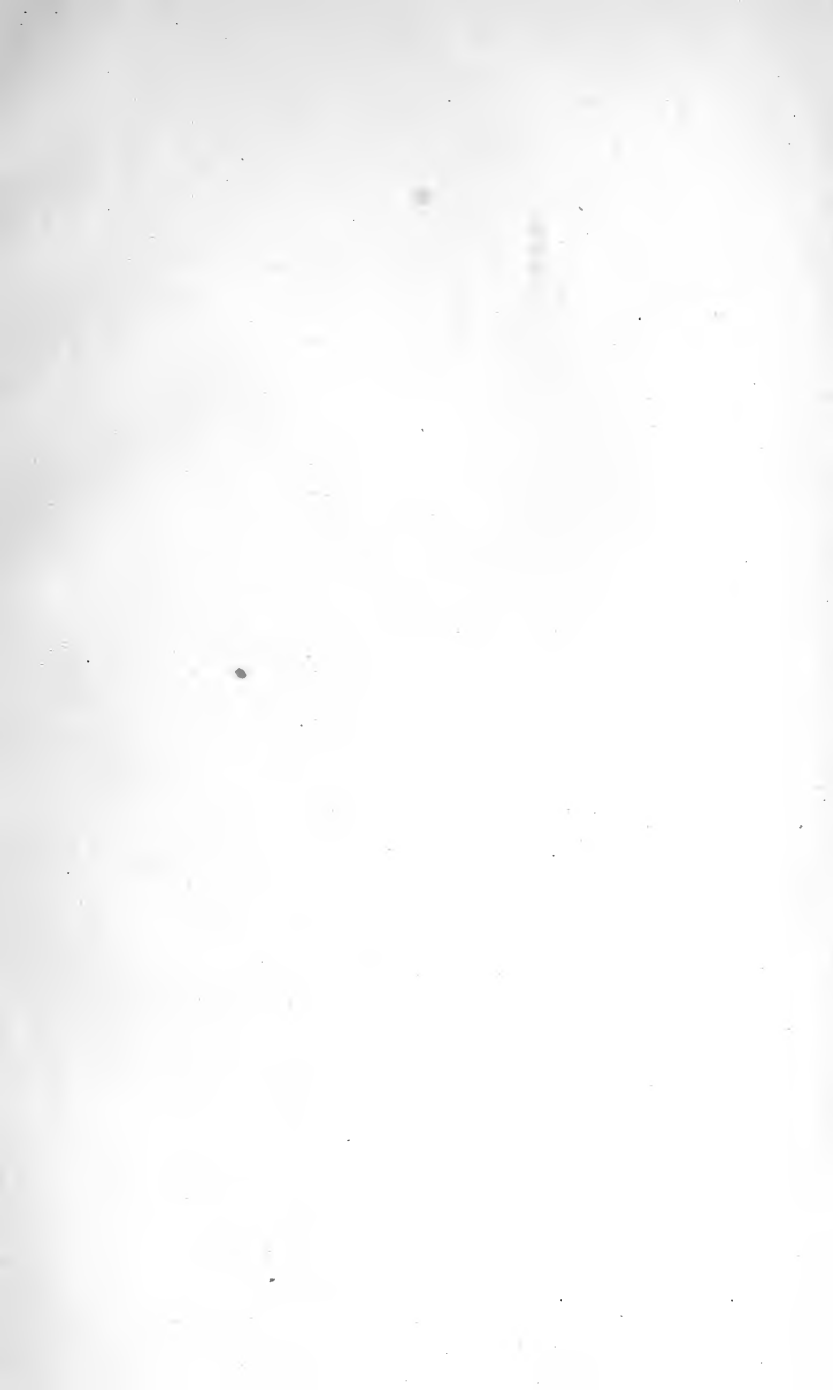

11 1904

18 1905

1903



